

RADIO'S LIVEST MAGAZINE



December
25 Cents
Canada 30¢

Radio-Craft

HUGO GERNSBACK Editor



The
Live
Canary
Talks

See Page 328

Jamen
Winter

NEW: "The Radio Month in Review"

YOUR DOLLAR BUYS MORE AT ALLIED

A FEW BARGAINS FROM OUR BOOK OF VALUES

"WORLD-WIDE" SPECIAL 7 TUBE RADIO
 15 to 2400 Meters
 4 separate wavebands
 Automatic volume control



SPECIAL PRICE
 Complete with Speaker and RCA Tubes
\$26.45

RCA Licensed



8 MFD. Electrolytic in metal can
38c

5 inch Magnetic Speaker
\$1.28

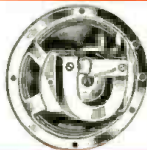

8000 ADDITIONAL BARGAINS IN THIS BIG BOOK OF VALUES



SPECIAL PRICES ON RCA and CUNNINGHAM TUBES

| | | |
|------------|------------|------------|
| 201A | 227 | 245 |
| 26c | 31c | 33c |

Mail Coupon Now

ALLIED RADIO CORP., 833 W. Jackson Blvd., Chicago, Ill.

Please send me Free your NEW 1934 Catalog.

Name _____

Address _____

City _____ State _____

Serviceman Dealer Engineer Experimenter

ALLIED COOPERATES

In spite of tremendous increases in the cost of labor and commodities, *thousands of items* in this book are being sold at *below the current market*. Hundreds of other items are being sold at prices that are still less than last year. *How was this achieved?* The answer is simple, *huge contracts, huge purchases*, made during the summer of 1933 when radio prices were at their *lowest in history*. Merchandise which was purchased at last year's low record prices is being passed on to our customers at tremendous savings. *Send for this Catalog now and save money.*



Here is the book that is making radio history. The most complete lines of quality radio sets, tubes, replacement parts, test equipment, and service men supplies, at the lowest wholesale prices.

SEND FOR THIS FREE CATALOG

LEADERSHIP

Thousands of radio dealers, service men, engineers and many broadcasting stations depend upon Allied for their radio needs. Allied consistently justifies this wide spread faith by offering a *complete* selection of high grade standard apparatus that can be counted on for *efficiency, long life and customer satisfaction*—at the lowest possible prices. Allied's huge stock enables you to get unusually *prompt and efficient* service. This is the simple secret of our great repeat business. If there ever was a time that you had to decide carefully where your money will buy its full money's worth, it is now. Allied will continue to protect you against unwarranted price increases to the fullest extent of its power. Allied's low net cash prices mean low, and will continue to mean low.

Allied Radio CORPORATION
 833 W. JACKSON BLVD. CHICAGO ILL.

OPPORTUNITIES

are many

for the Radio Trained Man

Don't spend your life slaving away in some dull, hopeless job! Don't be satisfied to work for a mere \$20 or \$30 a week. Let me show you how to get your start in Radio—the fastest-growing, biggest money-making game on earth.

Jobs Leading to Salaries of \$50 a Week and Up

Prepare for jobs as Designer, Inspector and Tester—as Radio Salesman and in Service and Installation Work—as Operator or Manager of a Broadcasting Station—as Wireless Operator on a Ship or Airplane, or in Talking Picture or Sound Work—HUNDREDS OF OPPORTUNITIES for a real future in Radio!

Ten Weeks of Shop Training

Pay Your Tuition After Graduation

We don't teach by book study. We train you on a great outlay of Radio, Television and Sound equipment—on scores of modern Radio Receivers, huge Broadcasting equipment, the very latest and newest Television apparatus, Talking Picture and Sound Reproduction equipment, Code Practice equipment, etc. You don't need advanced education or previous experience. We give you—RIGHT HERE IN THE COYNE SHOPS—the actual practice and experience you'll need for your start in this great field. And because we cut out all useless theory and only give that which is necessary you get a practical training in 10 weeks.

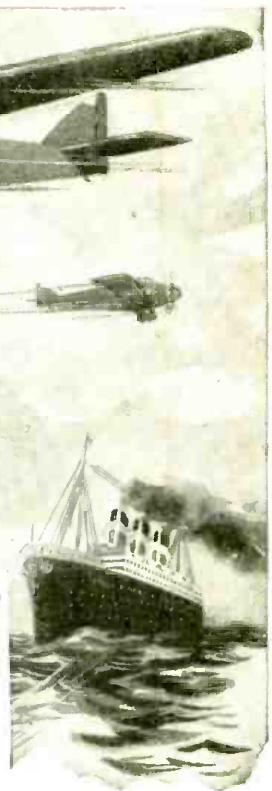

TELEVISION *and* TALKING PICTURES

And Television is already here! Soon there'll be a demand for THOUSANDS of TELEVISION EXPERTS! The man who learns Television now can have a great future in this great new field. Get in on the ground-floor of this amazing new Radio development! Come to COYNE and learn Television on the very latest, newest Television equipment. Talking Picture and Public Address Systems offer opportunities to the Trained Radio Man. Here is a great new Radio field just beginning to grow! Prepare NOW for these wonderful opportunities! Learn Radio Sound Work at COYNE on actual Talking Picture and Sound Reproduction equipment.

PAY FOR YOUR TRAINING After You Graduate

I am making an offer that no other school has dared to do. I'll take you here in my shops and give you this training and you pay your tuition after you have graduated. Two months after you complete my course you make your first payment, and then you have ten months to complete your payments. There are no strings to this offer. I know a lot of honest fellows haven't got a lot of money these days, but still want to prepare themselves for a real job so they won't have to worry about hard times or lay offs.

I've got enough confidence in these fellows and in my training to give them the training they need and pay me back after they have their training.

If you who read this advertisement are really interested in your future here is the chance of a life time. Mail the coupon today and I'll give you all the facts.

ALL PRACTICAL WORK At COYNE in Chicago

ALL ACTUAL, PRACTICAL WORK. You build radio sets, install and service them. You actually operate great Broadcasting equipment. You construct Television Receiving Sets and actually transmit your own Television programs over our modern Television equipment. You work on real Talking Picture machines and Sound equipment. You learn Wireless Operating on actual Code Practice apparatus. We

don't waste time on useless theory. We give you the practical training you'll need—in 10 short, pleasant weeks.

MANY EARN WHILE LEARNING

You get Free Employment Service for Life. And don't let lack of money stop you. Many of our students make all or a good part of their living expenses while going to school and if you should need this help just write to me. Coyne is 33 years old. Coyne Training is tested—proven beyond all doubt. You can find out everything absolutely free. Just mail coupon for my big free book!

H. C. Lewis, Pres. RADIO DIVISION Founded 1899

COYNE Electrical School

500 S. Paulina St., Dept. 93-8H, Chicago, Ill.

Mail Coupon Today for All the Facts

H. C. LEWIS, President

Radio Division, Coyne Electrical School

500 S. Paulina St., Dept. 93-8H, Chicago, Ill.

Dear Mr. Lewis:— Send me your Big Free Radio Book, and all details of your Special Offer.

Name

Address

City.....State.....



HUGO GERNSBACK, Editor-in-Chief

C. W. PALMER
Associate Editor

R. D. WASHBURNE
Technical Editor



IN OUR NEXT FEW ISSUES:

HOW TO MAKE THE RADIO "GROWLER." While the equipment for the radio "growler" is quite simple and, in fact, is familiar to every experimenter and radio Service Man, the tests possible with this simple apparatus are really astounding. After you have read the article, or perhaps even before, you will dig down into your "junk box" and start collecting the parts needed to make this test unit. The apparatus is so useful that even "Ye Editor" bent his venerable head into "ye junk box" to make one.

AN ULTRA-MODERN SET ANALYZER. The author of this article used seven different commercial makes of analyzers, in his work as Service Man for a Metropolitan servicing firm, and learned the advantages and short-comings of each, in the course of servicing over 5,000 "sick" sets, before he designed the unit which will be described. The purpose of designing this unit was to avoid the failings of the available commercial units. If you are a Service Man and work day-in and day-out with sets that have gone "hors de combat," you are naturally interested in having the best equipment available. You should read the description and instructions for making this analyzer without a fault.

RADIO-CRAFT is published monthly, on the fifth of the month preceding that of date; its subscription price is \$2.50 per year. (In Canada and foreign countries, \$3.00 a year to cover additional postage.) Entered at the post office at Mt. Morris, Ill., as second-class matter under the act of March 3, 1879.

Text and illustrations of this magazine are copyright and must not be reproduced without permission of the copyright owners. We are also agents for WONDER STORIES and EVERYDAY SCIENCE AND MECHANICS. Subscription to these magazines may be taken in combination with RADIO-CRAFT at reduced Club rates. Write for information.

Copyright 1933. Continental Publications, Inc.

HUGO GERNSBACK, President I. S. MANHEIMER, Secretary

Published by Continental Publications, Inc. Publication office: 404 N. Wesley Ave., Mount Morris, Illinois. Editorial and Advertising Office: 96-98 Park Place, New York City. Chicago Advertising Office: 919 North Michigan Avenue, Chicago, Ill. Western Advertising Office: 511 So. Alexandria St., Los Angeles, Calif. L. F. McClure, Chicago Advertising Representative. Loyd B. Chappell, Western Advertising Representative.

London Agent: Hachette & Cie., 3 La Belle Sauvage, Ludgate Hill, E.C. 4
Paris Agent: Hachette & Cie., 111 Rue Reamur
Australian Agent: McGills Agency 179 Elizabeth St., Melbourne

CONTENTS OF THE
DECEMBER, 1933, ISSUE

VOLUME V NUMBER 6

Editorial: Aging Radios.....Hugo Gernsback 327
 The Talking Canary!.....Hugo Gernsback 328
 How to Make a Real Velocity "Mike".....H. G. Cisin 329
 The Radio Month in Review..... 330
 Recent Radio Developments—Illustrated..... 332
 "Elizabeth Air Radio"..... 333
 Now, as Predicted—a Pocket-Size Loudspeaker Set.... 334
 Latest Radio Equipment..... 336
 A 5-Unit Radio Tester for Complete Set Analysis..... 337
 A Super-Power and -Quality P.A. System..... 338
C. W. Palmer
 International Radio Review..... 339
 How to Make a Modern Car Radio Set, Part I..... 340
Heinz A. Mueller
 The Beginner's "Unit Chassis" Crystal and 2-Tube Superhet..... Francis R. Harris 342
 The Schoolboys' I-Tube Receiver..... 343
 Radio Short-Cuts 344
 Readers' Department 345
 The Newest in All-Wave Superheterodynes, Part II 346
McMurdo Silver
 Servicing the "Talkies"..... Aaron Nadell 347
 Servicing by Stage Analysis..... Joseph Kaufman 348
 How to Make a Compact, Powerful 6 V., D.C. and 110 V., A.C. I-Unit P.A. System.....Louis Gancher 349
 How to Install a Remote Control on I-Dial Sets..... Hubert L. Shortt 350
 Operating Notes 351
 RADIO SERVICE DATA SHEETS:
 No. 103—Majestic Models 440, 500 and 800 Superheterodyne Receivers 352
 No. 104—Stromberg-Carlson No. 33 6-Tube Automotive Radio Receiver..... 353
 Building the New 1934 Ultra-Modern Super..... Clifford E. Denton 354
 RADIO-CRAFT'S Information Bureau..... 356

I will help You start a Spare Time or Full Time Radio Service Business without capital



**J. E. SMITH, President
National Radio Institute**
The man who has directed the Home-Study Training of more men for the Radio industry than any other man in America.

Here are a few examples of the kind of money I train "my boys" to make

\$50 to \$75 a Week



"The National Radio Institute put me in a position to make more money than I ever made in good times. I am in the radio service business for myself, where it is possible for me to make from \$50 to \$75 a week. Service work has increased because people, who in normal times would buy a new Radio, now are contented to have the old one 'pepped up'."—**BERNARD COSTA**, 150 Franklin St., Brooklyn, N. Y.

\$500 a Year Extra in Spare Time



"Although only doing spare time Radio work, I averaged about \$500 extra a year in addition to my regular income. Full-time Radio work would net me many times that amount. My example and that of hundreds of other N. R. I. graduates should convince any skeptical person of the superiority of N. R. I. training."—**EDWARD H. FAWCETT**, Slough Road, Ladner, B. C., Canada.



Averages \$80 per Month in Spare Time

"I am getting along well in my Radio work, always being kept very busy. Since enrolling I have averaged around \$80 a month working on Radio just part time, since I am still holding down my regular job."—**JOHN B. MORISSETTE**, 733 Somerville St., Manchester, N. H.

My Free book gives you many more letters of N. R. I. men who have made good in spare time or full time businesses of their own

SPECIAL Radio Equipment for Broad Practical Experience Given Without Extra Charge

My Course is not all theory. I'll show you how to use my special Radio equipment for conducting experiments and building circuits which illustrate important principles used in such well-known sets as Westinghouse, General Electric, Philco, R.C.A., Victor, Majestic, and others. You work out with your own hands many of the things you read in our lesson books. This 50-50 method of training makes learning at home easy, interesting, fascinating, intensely practical. You learn how sets work, why they work, how to make them work.

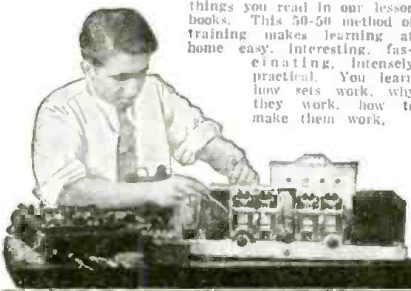

without capital

Free Book Tells How Mail Coupon!

The world-wide use of Radio sets for home entertainment has made many opportunities for you to have a spare-time or full-time Radio business of your own. I give you instructions early in your course for doing 28 Radio jobs common in almost every neighborhood. Many N. R. I. men make \$5, \$10, \$15 a week extra in spare time almost at once. I show you how to install and service all types of receiving sets. I give you Radio equipment and instructions for conducting experiments, for building circuits and testing equipment, and for making tests that will give you broad, practical Radio experience. Clip the coupon below and get my free 64-page book, "Rich Rewards in Radio"—it gives you a full story of the success of N. R. I. students and graduates, and tells how to start a spare-time or full-time Radio business on money made in spare time while learning.

Many N. R. I. Men Make \$5, \$10, \$15 a Week Extra in Spare Time Almost at Once

Many of the seventeen million sets now in use are only 25 per cent to 40 per cent efficient. I will show you how to cash in on this condition. I will show you the plans and ideas that have enabled many others to make \$5, \$10, \$15 a week in spare time while learning. Ford R. Leary, 1633 Davidson Road, Flint, Mich., wrote: "My part-time earnings while taking the N. R. I. Course were \$651."

Get Ready Now for a Radio Business of Your Own and for Jobs Like These

Broadcasting stations use engineers, operators, station managers, and pay up to \$5,000 a year. Radio manufacturers use testers, inspectors, foremen, engineers, servicemen and buyers, and pay up to \$7,500 a year. Radio dealers and jobbers employ hundreds of servicemen, salesmen, managers, and pay up to \$5,000 a year. Radio operators on ships enjoy life, see the world, with board and lodging free, and get good pay besides. My book tells you of the opportunities in Radio, Set Servicing, Aircraft Radio, Television, Police Radio, Short Wave, and other fields. Get it.

I Will Train You at Home in Your Spare Time

Hold your job until you're ready for another. Give me only part of your spare time. You do not need a high school or college education. Hundreds with only a common school education have won bigger pay through N. R. I. J. A. Vaughn jumped from \$35 to \$100 a week. J. E. McLaurine increased his earnings 100 per cent. The National Radio Institute is the Pioneer and World's Largest organization devoted exclusively to training men and young men by Home Study for good jobs in the Radio industry.

You Must Be Satisfied

I will give you an agreement to refund every penny of your money if you are not satisfied with my Lessons and Instruction Service when you complete my Training. And I'll not only give you thorough training in Radio principles, practical experience in building and servicing sets, but also Advanced Training in any one of five leading branches of Radio opportunities.

Free Book of Facts

Mail the coupon for "Rich Rewards in Radio." It's free to any ambitious fellow over 15 years old. It tells you about Radio's spare-time and full-time opportunities; about my training; what others who have taken it are doing and making. Mail coupon now.



J. E. SMITH, Pres.
Dept. 3NX,
National Radio Institute,
Washington, D. C.



Special FREE Offer

Act now and receive in addition to my big free book, "Rich Rewards in Radio," this Service Manual on D.C., A.C., and Battery operated sets. Only my students could have this book in the past. Overcoming hum, noises of all kinds, fading signals, broad tuning, howls and oscillations, poor distance reception, distorted or muffled signals, and other vital information is contained in it. Mail coupon for free copy.



THIS COUPON IS GOOD FOR ONE FREE COPY OF MY NEW BOOK mail it TODAY

J. E. SMITH, President,
National Radio Institute, Dept. 3NX,
Washington, D. C.

Dear Mr. Smith: I want to take advantage of your Special Offer. Send me your two books, "Trouble Shooting in D.C., A.C., and Battery Sets" and "Rich Rewards in Radio." I understand this request does not obligate me. (Please Print Plainly.)

Name _____ Age _____
Address _____
City _____ State _____ M

The Famous Course That Pays For Itself



YOUR COPY OF THE 1934

OFFICIAL RADIO SERVICE MANUAL IS READY!



THE necessity of GERNSBACK Manuals in the radio field has been shown by the fact that the total sales of the first three OFFICIAL RADIO SERVICE MANUALS, including the new CONSOLIDATED EDITION, now exceed 80,000 copies. Radio Service Men and others engaged in various branches of radio know the importance of such books, and how they must depend upon them for reliable information. Whether for public-address work, tube information or a circuit diagram, the material needed is certain to be found in one of the OFFICIAL RADIO SERVICE MANUALS. The GERNSBACK Manuals have been constantly used in reference work by leading radio set manufacturers, mail-order houses, jobbers, dealers and, most extensively, by Service Men, for whom these books are invaluable.

In the planning of the 1934 OFFICIAL RADIO SERVICE MANUAL many things have been taken into consideration. First, how we could reduce our own costs, and in turn pass these savings on to our readers. Second, what information not contained in previous editions of the Manuals must be incorporated in the 1934 edition and would be of utmost importance to its users. Third, what advance information we could print that would be useful in the future.

After careful analysis we found that the total cost of producing the 1934 Manual would be considerably less than in former years, and that at this time we could reduce the price of the book to our readers. The Fourth Edition of the OFFICIAL RADIO SERVICE MANUAL will sell this year for \$3.50. The book will be published like the 1933 Manual—the volume will be sent to you complete. As usual, we urge that all our readers place their order early so that they will get a copy of the first printing. Usually, at the last minute a tremendous number of orders come to us and quite often orders are held up while the book is going through a second printing.

In preparing this new edition many of the outstanding problems of the Service Men have been considered—methods of servicing, the new equipment constantly needed to cope with new tubes and sets, and the other fields of radio, such as public-address systems, short waves, auto radio and others.

As in previous years, the 1934 Manual will also include a FREE QUESTION AND ANSWER SERVICE. In each book will be found 25 coupons, which entitle you to free consultation on any radio service topics. These coupons give you a complete mail service—questions on servicing and operating on any set or circuit are answered promptly and accurately by the editors. Remember that, at the regular rate of 25c per question which is usually charged by radio magazines, this service alone is worth \$6.00. And for the Manual, we charge only \$3.50.

It is quite evident that the 1934 Edition of the OFFICIAL RADIO SERVICE MANUAL will be a decided improvement over previous volumes, and will even surpass the high standard of the former Manuals.

ORDER YOUR COPIES NOW

It is important to every Radio Service Man and Dealer that he receive his copy of the 1934 OFFICIAL RADIO SERVICE MANUAL as soon as it is published. The new book will prove itself to be invaluable as those volumes of previous years. The book as usual comes to you postpaid and free of additional charges.

No need to delay sending us your order—the 1934 MANUAL, like its predecessors, is a necessity in your business. We strongly advise you to order your copy today, and then you will be certain to get one from the first printing of the book. The 1934 Manual is now ready for delivery.

Mail the coupon today.

Contents of the 1934 Manual in Brief

- Diagrams and service notes, more complete than ever before in any MANUAL. Not merely the schematic hook-ups will be found, but also chassis drawings showing parts layouts, positions of trimmers, neutralizers, etc.
- Voltage readings for practically all sets, as an aid in checking tubes and wiring.
- All values of intermediate-frequency transformers used in super-heterodynes, with the manufacturers' own suggestions as to correct balancing.
- Detailed trouble-shooting suggestions and procedure as outlined by the manufacturers' own engineers—in other words, authentic "dope" right from headquarters.
- Values of all parts indicated directly on all diagrams. WE WILL POSITIVELY NOT INCLUDE DIAGRAMS FOR WHICH PARTS VALUES CANNOT BE OBTAINED.
- A special section for reference to A.C.-D.C. cigarbox midgets.
- A special section for reference to automobile radio.
- A special section for reference to public-address amplifiers.
- A special section for reference to short-wave receivers.
- A special section for reference to remote-control systems.
- A complete compilation of radio tube data, covering both the old and the many new types.
- A special section devoted to test equipment, analyzers, etc., with full diagrams and other valuable information.
- A complete list of American broadcast stations with their frequencies in kilocycles; extremely useful in calibrating and checking test oscillators and in calibrating receivers.
- Free Question and Answer Service, the same as in our last two Manuals.
- No theory; only service information in quickly accessible form.
- Absolutely no duplication of any diagrams; nothing that appeared in any of the previous Manuals will appear in the 1934 MANUAL. This we unconditionally guarantee.
- A handy, easily-consulted master Index making it easy for you to find almost anything pertaining to your service problem instantly. This index will include all the diagrams published in all the previous GERNSBACK Manuals, as well as the 1934 diagrams. A big convenience and time saver!

The illustrations in the 1934 Manual will be more explicit than before; inasmuch as the diagrams will not be limited to the schematic circuit, but other illustrations will show the parts layout, positions of trimmers, neutralizers, etc. There will be hundreds of new circuits included, and not one from any previous edition of the manuals will be repeated. *This we unconditionally guarantee.*

The number of pages in the new Manual will exceed 400, with hundreds of illustrations, including diagrams, charts, photos, picture layouts, etc. The size of the Manual will be the same as that of the former volumes—9x12 inches, with a flexible, loose-leaf binder.

GERNSBACK PUBLICATIONS, Inc.
96-98 Park Place, New York, N. Y.

Gentlemen: Enclosed you will find my remittance of \$3.50 for which you are to send me, *postage prepaid*, One Copy of the 1934 OFFICIAL RADIO SERVICE MANUAL. [Send remittance by check or money order; or register letter if it contains cash, currency or unused U. S. postage stamps.]

Name.....

Address.....

City..... State.....

RC-1233



... say these **30**
Leading Radio
Manufacturers
 . . . to their **40,000**
DISTRIBUTORS
and DEALERS
 throughout United States
 and Canada

- AMERICAN BOSCH**
AMERICAN TELEVISION
ARCTURUS TUBES
BALKEIT • BRUNSWICK
CAPEHART
CLOUGH-BREngle CO.
CROSLY • CLARION
DeFOREST • ECHOPHONE
FADA • GREBE • HOWARD
HAMMERLUND • HICKOK
INTERNATIONAL
RESISTANCE CO.
KENNEDY • KOLSTER • LYRIC
MAJESTIC • PHILCO
RADIO PRODUCTS CO.
SANGAMO ELECTRIC
SENTINEL • SHELDON
SILVER-MARSHALL CO.
STEWART RADIO
STEWART-WARNER
STROMBERG-CARLSON
UNIVERSAL MICROPHONE
ZENITH

The need for men, PROPERLY trained, is one of the Radio Industry's major problems, today. In fact, the very future of the Radio Industry is dependent on the industry having available, at all times, an adequate supply of PROPERLY trained men to install and service—not only the present-day highly complicated Radio and Electronic equipment—but the still more complicated equipment that will be brought out by the Industry, from time to time. The above manufacturers all realize this. They know that under such circumstances, no ordinary Radio Training is going to give them the type of "trained" man they want. Only a Training that is right-up-to-the-minute, and properly prepared, highly practical, and properly supervised, will answer their purpose. Radio and Television Institute home-training has successfully met their every test. That's why these manufacturers recommend R. T. I. Training, not only to their own men, everywhere—but to all men who want to get somewhere in Radio.

*This entire advertisement approved by the above thirty-two manufacturers. Copyright 1933 by R.T.I.

LEARN RADIO FROM REAL RADIO ENGINEERS



HERE THEY ARE:

- Dr. C. M. Blackburn, Chief Radio Engineer, Galesby-Grunow Company (Majestic).
- Kendall Clough, Chief Engineer Clough-Brengle Co. (Radio Engineers and Manufacturers).
- Karl Hassel, Chief Engineer, Zenith Radio Corporation.
- Homer Hogan, Gen. Manager, Radio Station KTW, Chicago.
- R. MacGregor, Service Manager and Sales Engineer, Transamerica (Clarion).
- H. C. Fittle, Chief Radio Engr., Stewart-Warner Corporation, Chicago Plant.
- F. D. Whitten, Service Manager, Philco Radio and Television Corporation, —and R.T.I. Staff.



LET THESE ENGINEERS RIGHT FROM THE HEART OF THE BIG RADIO INDUSTRY Train You at Home for

GOOD PAY RADIO WORK

To the man who wants to make \$35 to \$75 a week and more—Here's a Message for You!

"The great Radio Industry, today—more than ever before—is on the lookout for PROPERLY trained men to fill its more responsible jobs. These are the better-paying jobs in Radio . . . jobs which give steady work at good pay, as a starter; and an early advancement to still better-paying jobs, as a future."

HERE, THEN, IS REAL OPPORTUNITY

But to qualify for these better-paying jobs, men must be PROPERLY "trained"—they must know the theory of Radio, as well as the practical side, and be able to teach other men some of the things they know. The Radio Industry, itself, has no time to train these men. That's why the Radio & Television Institute, of Chicago, is doing the job. You'll be trained at home—in your spare time—easily and quickly, and at a cost of only a few cents a day. And as you are taught to "earn as you learn"—R. T. I. Training need cost you nothing.

R.T.I. TRAINING IS "SHOP TRAINING" FOR THE HOME

It comes to you right from the Radio Industry—right out of the factories where Radio sets and other vacuum-tube devices are made. It was planned and prepared for you by big radio engineers IN these factories, most of whom are the Chief Engineers of these great Radio plants. And NOW these same engineers are actually supervising R. T. I. Training. Which means that trained the R.T.I. way, you'll be trained as the Radio Industry wants you trained—just as the Radio Industry, itself, would train you if it was doing the job.

You learn by doing, of course, because that's the Shop Way of teaching. But you also learn the theory of Radio—without which you can't hope to go far, or make much money, in this great industry.

ELECTRONICS—SOUND PICTURES P. A. SYSTEMS—PHOTO CELLS— TELEVISION—all included

Radio service is just the starting point in R.T.I. Training. From there we take you up through the very latest developments in Radio, and

then on into the new and larger field of Electronics—Sound Pictures, Public Address Systems, Photo Cells, and Television. This feature alone makes R. T. I. the outstanding home training in Radio.

YOU GET "QUICK RESULTS"

C. E. Head, 431 Third St., Alexandria, La., Says: "Made my first money 11 days after starting your training—cleared \$14.25."

Frank E. Klemann, Lisle, Ill., writes: "Doubled my pay in less than six months."

Harry L. Stark, Ft. Wayne, Ind., writes: "Now making three times as much money as I was making when I started your training."

So, if you want to get out of a small pay, no-future job, and into good pay, big-future work—get into Radio. But let these big engineers direct your training.



MAIL COUPON FOR FREE BOOK

Let me tell you more about this amazingly easy Shop-Type home-training, and more about the wonderful opportunities for the R. T. I. TRAINED man in this—the world's fastest growing industry. Everything is fully explained in my big, new booklet . . . "RADIO'S FUTURE, AND YOURS." Send today for your copy. The book is free.

Ray D. Smith, President, Radio and Television Institute, Chicago

Ray D. Smith, President,
 RADIO and TELEVISION INSTITUTE, (R.T.I.),
 2130 Lawrence Ave., Dept. 69, Chicago, Ill.
 Without obligation of any kind please send me a copy of "Radio's Future and Yours." I am interested in your home training and the opportunities you say exist in the great field of Radio for the R.T.I. Trained man.

Name _____
 Address _____
 City _____ State _____

SERVICE ENGINEERS' POWER UNIT EMERGENCY STOCK

Only Four Models
FOR 90% OF ALL RADIOS

Easily Installed!
FULL DIRECTIONS WITH EACH UNIT

Radio Service Engineers now can give prompt service in cases of trouble in transformers—the heart of the radio. To meet this urgent demand for immediate service on proper replacement transformers, the GENERAL has developed four models of "MULTI-TAP" UNIVERSAL POWER TRANSFORMERS, to service over 90% of all models of Radios—"orphaned" and current models.

- 110-120 V. 50-60 cy.
- 220-240 V. 60 cy.
- 115 V. 25 cy.

"MULTI-TAP" UNIVERSAL POWER TRANSFORMERS

(Patent Applied For)



Foreign, and other radio servicers far from manufacturing markets, find "Multi-Tap" Universals essential to satisfy their trade. These units are fully shielded, designed for meeting the specification of radios having Underwriters Laboratory approval. This is very important as many states now require such approval to protect the set owner's fire insurance policies. The shells are easily snapped off and on—are insulated inside to insure against short-circuiting the terminals. Furnished in dull satin black finish, unless otherwise ordered.

"MULTI-TAP" UNIVERSAL POWER TRANSFORMERS' ELECTRICAL CHARACTERISTICS

| | | | |
|--|--|--|---|
| (For 4 Tubes) | | (For 7 or 8 Tubes) | |
| 2-24, 27, 35, 55, 56, 57, 58, 2A6, 2A7, 2B7, 90 and 1-45, 46, 47, 59, 2A3, 2A5 1-80, 80M, 83, 5Z3 or 1-82 High Voltage | 650 volts | 4-26s or 4-24, 27, 35, 55, 56, 57, 58, 2A6, 2A7, 2B7, 90 1 or 2-27 2-45, 46, 47, 59, 2A3, 2A5 or 2-171A 1-80, 80M, 83, 5Z3 or 1-82 High Voltage | 700 volts |
| (For 5 or 6 Tubes) | | (For 9 or 10 Tubes) | |
| 3-26s or 3-24, 27, 35, 55, 56, 57, 58, 2A6, 2A7, 2B7, 90 1 or 2-27 2-45, 46, 47, 59, 2A3, 2A5 or 2-171A 1-80, 80M, 83, 5Z3 or 1-82 High Voltage | 650 volts | 6-26s or 6-24, 27, 35, 55, 56, 57, 58, 2A6, 2A7, 2B7, 90 1 or 2-27 2-45, 46, 47, 59, 2A3, 2A5 or 2-171A 1-80, 80M, 83, 5Z3 or 1-82 High Voltage | 700 volts |
| | 2.5vC.T.—5.25 Amp 5.0v—3.0 Amp 2.5v—3.0 Amp C.T. at 50 MA | | 1.5v—4.20 Amp 2.5v—7.0 Amp 2.5vC.T.—3.0 Amp 2.5v—3.5 Amp 5.0vC.T.—0.5 Amp 5.0v—3.0 Amp 2.5v—3.0 Amp C.T. at 80 MA |
| | 1.5v—3.15 Amp 2.5v—5.0 Amp 2.5v—3.5 Amp 2.5vC.T.—3.0 Amp 5.0vC.T.—0.5 Amp 5.0v—3.0 Amp 2.5v—3.0 Amp C.T. at 60 MA | | 1.5v—6.5 Amp 2.5v—10.5 Amp 2.5v—3.5 Amp 2.5vC.T.—3.0 Amp 5.0vC.T.—0.5 Amp 5.0v—3.0 Amp 2.5v—3.0 Amp C.T. at 100 MA |

EXACT DUPLICATES ELECTRICALLY

The wide range of adaptability of only four models "Multi-Tap" Universal Power Transformers is made possible through various taps in these units, which may be used singly or in combinations. With this variety of combinations in the four models, the required current values can be delivered to each of the several leads

in the set for any combination of tubes used in 1377 models of 4 to 10-tube receivers as accurately as the original power units—considering the variation in the lighting current of different localities. The important consideration in replacing power units is how many tubes in the set and their current requirements—not what tubes or what make of radio.

"Multi-Tap" Universal Output Transformer



Universal-Electrically
The universal primary and the tapped secondary from 2 to 30 ohms in 2 ohm steps make it possible to feed practically any straight or push-pull output stage to any dynamic speaker.
Universal-Physically
May be mounted on end or side. Slots in base allow wide range of adaptability without redrilling panel.

Universal Input Audio Transformers

This input audio efficiently feeds any straight or push-pull audio stage on either AC or DC set.
Overall Dimensions:
2 x 2 3/8 x 1 5/8
Mtg. Centers:
1 1/4 x 1/2 to 1 9/16 or
1 1/4 x 1/2 to 1 9/16 or
Dimensions the same on Output and Input Transformers.

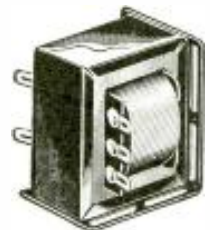

MAIL THIS COUPON NOW!

GENERAL TRANSFORMER CORPORATION,
504 So. Throop Street,
Chicago, Ill.

Please send free Bulletin of "Multi-Tap" Universals and list of Radios on which they can be used for replacements.

Name
Address
My Jobber is
Address

FREE! GENERAL Illustrated and fully descriptive BULLETIN!

with complete list of 1377 models and makes of radios on which you can replace power units out of a stock at an investment of only \$23.25 (list) in "Multi-Tap" Universals.

**GENERAL
TRANSFORMER CORPORATION**
504 So. Throop Street Chicago, Illinois



"Takes the Resistance Out of Radio"

Editorial Offices: 96-98 Park Place, New York, N. Y.

HUGO GERNSBACK, Editor

Vol. V., No. 6, December, 1933

AGING RADIOS

An Editorial by HUGO GERNSBACK

A POINT frequently overlooked by radio manufacturers, radio Service Men and radio set users, is that there is such a phenomenon as aging of radio receivers.

By aging is meant the process of deterioration in a radio set; just as, for instance, the human body deteriorates by age.

Marvelous machine though the human body is, age, when it encroaches upon the body, ravages it, as we all know. The same deterioration goes on in a radio set, although this fact may not be apparent at first.

There are few materials, which can be fabricated and put together in conjunction with other materials, that will not in time deteriorate in some manner. Even metals crystallize and, in due time, weaken.

Leaving out the radio tubes which, of course, age too, and must be replaced periodically, let us first consider the chassis, which, at first glance looks solid enough, and theoretically should not deteriorate at all. The opposite is the case, however. Your radio set in the summertime is quite a bit larger than in the winter. Heat expands, cold contracts; the radio chassis is no exception to this universal law, although some manufacturers do not seem to be aware of it. When things begin to stretch, then contract, and do this frequently, something is bound to give. Rivets and screws, no matter how well fastened, in time begin to give way. Don't forget, also, that the radio set is heated to a comparatively high temperature by the radio tubes, by its resistors, and by the transformers—all of which are not any too well ventilated—and while the set is in use, the expansion of the chassis and other parts is considerable. When the set is turned off, particularly on a cold day, the shrinking process is rapid, and something gives way even if the movement is microscopic. In due time, however, you begin to notice that the set is not the same as before. Even if there were no parts on the radio set, besides the chassis, to age; sockets, for instance, become loose; contacts loosen, etc. The variable condenser, no matter how well made, is affected by the aging process; its bearings particularly must, sooner or later, begin to wear. This makes for changes in the capacity of a condenser; sometimes it even causes short circuits of the stator and the rotor; and, unless a condenser is extremely well engineered, the tuning is apt to become noisy and scratchy, because of the failing of the aging springs, of the rotor.

Turning our attention to the fixed condensers, let no one think that even the best of fixed condensers is immune to old age. It should not be forgotten that the electrical current sets up continuous, and comparatively tremendous, stresses in the dielectric of most fixed condensers and these stresses wear down even the best mica condenser. Of course, condensers heat up too, and therefore contract and expand; and even a molded condenser will, in time, show aging effects.

True, a good one will stand up for a considerable time; but we doubt if any engineer would guarantee even the best molded condenser for a ten-year stretch, much less twenty years. In electrolytic condensers, the aging process is much more rapid. The chemicals in such condensers will not last forever; they dry out and, by chemical action, the elements otherwise age. The average life of even the best electrolytic condenser at the present state of the art is certainly not much more than two years.

When we come to resistors, the situation seems to be a little better, except for those that carry a high current. In that case, the continual contraction and expansion, as well as the crystallizing of the conductor, tend to cut the life of such resistors. Those that pass a low current come out better and will last for many years, if well designed and engineered. The open-wire resistor does not fare so well in the aging process since the accumulation of dust on it, etc., all tend to cut down its life.

Variable resistors, such as are used for volume controls, as Service Men well know, do not last for a great length of time. Naturally, anything that is handled mechanically, as often as a volume control or a variable condenser, must, in time wear out, even if only mechanically so; but in most cases, the resistance element will wear out first unless, of course the volume control is engineered with extreme care.

Coming to transformers, particularly the power transformers, the aging process in these is rapid also. Not only has the transformer to stand a great amount of heat, which continuously causes expansion of its elements, but this stretching of the primary and secondary, as well as of the insulation has its natural effect in due time; and unless this factor is taken cognizance of by the manufacturer, the life expectancy of the transformer will be short. Service Men know this well, and, as a rule, they look first for trouble in the power transformer, because here is where the aging process is apt to appear earlier than anywhere else. Even the best-designed transformers do not stand up indefinitely. It is an unusual transformer that will give service for five years.

As to the loudspeaker, whether dynamic or otherwise, it is well known that, because of the continuous vibration, no material has been found as yet for cones that will last for any great length of time. Two or three years would seem to be the maximum for the cone which ultimately loosens and must be replaced.

The speaker itself, from the continuous expansion and contraction, naturally loses some of its quality over the course of years. By replacing the cone, however, and making other minor adjustments, the loudspeaker should be good for many years, with proper care.

Then, we have the wiring itself, which deteriorates too. This is particularly the case with rubber insulation because, under the continuous heating of the set, such insulation soon becomes hard and brittle; and the vibration from the loudspeaker, as well as other natural vibration, loosens and destroys the insulation as time goes on.

From all of this, it will be seen that the former idea that a radio set never wears out like, for instance, an automobile, is erroneous. This is a world in which practically nothing lasts forever. Radio sets are no exception.

And it should be noted that, notwithstanding all this, we should not think of criticizing our manufacturers; because they, themselves, have no remedy today for the aging processes. Materials cannot yet be protected against the ravages of time. Such a time will, conceivably, arrive; but it may be centuries before man can control aging processes, not only in material things, but in his own body as well.

• THE TALKING CANARY!

HUGO GERNSBACH

Experimenters and Service Men — here is one of the most amazing ideas which has yet come down the line; too, it has commercial possibilities. Whether the instrument serves a tragi-comic or commercial role is a matter for the constructor to decide; the author discusses the complete procedure to be followed in either instance. Either a reproducer or a microphone inside a bird cage, is connected to an amplifier for the purpose of reproducing or picking up the sounds of whistling, music, or speech, as the case may be.



The "radio bird cage," ready for business.

THERE are quite a few pretty "sound effects" which seem to have been overlooked so far. Those who have canaries in their homes have probably noticed that these birds do not always sing. For a number of reasons, their singing seems to be influenced by a number of things which are, as yet, not well understood. Some birds need encouragement; and a number of the bird stores are selling whistles with which to urge on the birds.

Some time ago, I tried a number of experiments along these lines, which turned out exceedingly well. In one of the photographs it will be seen how the top of the bird cage is opened up, and the Baldwin speaker unit inserted in it. Holes are drilled in the metal plate under the unit, to permit the sound to be projected into the cage. The cage is now wired for sound, by running the wire to an amplifier, thence to a phonographic pickup. I secured a number of R.C.A. Victor records, the numbers and designations of which are as follows:

V-1-A Actual Song of the Canary Bird.

V-66-B Les Sirens (Canaries and Nightingales with Orchestra)

20968-B Nightingales (actual)

V-15-A Forest Concert (Nightingales and Warblers).

It was found that these bird records, when run through the phonograph and

amplifier, encouraged the bird a good deal and, providing the music was not too loud, the canary, after a while, became enthusiastic and warbled along with the music of the record. There is only one Victor record which is pure canary songs without accompaniments. (No. V-1-A). I have found a peculiar thing in connection with this record that will be of interest. If the record is played through the usual dynamic speaker, it proves disappointing, because most of the larger dynamics do not reproduce the exceedingly high notes of a canary bird well. With a Baldwin unit and its smaller diaphragm, I had no such difficulty and the music came out loud; certainly loud enough to influence the bird in the cage.

A variation of this scheme, which may be used to surprise your friends or the household staff, is shown in another illustration. Of course, in order to introduce the element of surprise no one is supposed to know that you wired the cage; and the wiring, naturally, must be exceedingly fine so it will not be seen. You are then to conceal yourself and talk through a hand mike and a two-stage amplifier. The live bird, of course, is in the cage. You start talking when someone enters the room and, inasmuch as the bird usually whistles or opens its mouth, the voice seems to come from him; and you have the realistic effect of a talking live bird

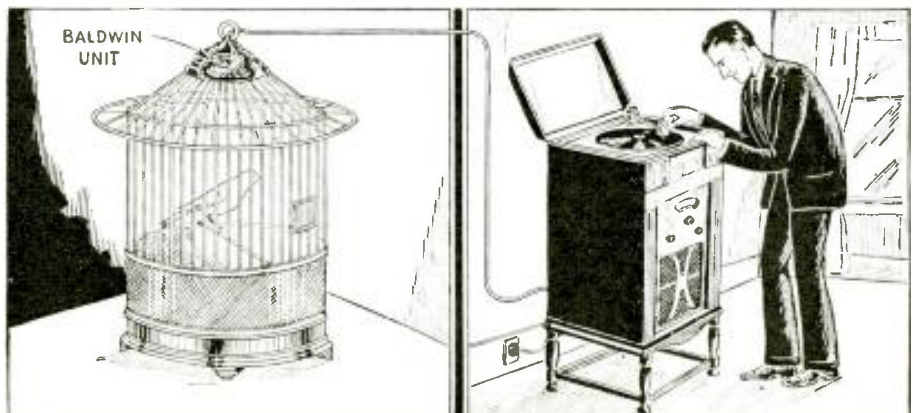

A canary singing "like the birdies sing," via phonograph.

which, at times, not only causes surprise, but consternation. It has been found, with one exception, that a bird will usually twitter, being himself surprised at the strange voice; unless, of course, the experiment is done too often, when he will get used to it and keep his mouth closed.

For parties, entertainment, etc., this is a very good effect, and usually will bring a good deal of applause. Of course, the cage may also be connected directly to your radio set; thus you may do away with the amplifier and use the Baldwin unit as a loudspeaker and, provided it is not overloaded, you can use this extra outlet in the canary cage as a remote loudspeaker connected to any radio set. If the bird is at all musical, he will enjoy the music; always providing that you do not blast him and frighten him by excessive sound.

After awhile, the bird gets used to the music, and will begin to sing whenever the cage speaker is turned on.

Another variation which can be used with great success, particularly by Service Men, and which, to the best of my knowledge, has never been used before, is as follows:

Every bird store should be an immediate outlet for this scheme. Instead of the Baldwin unit, a microphone is placed somewhere in the cage. The outfit is then carried to a P.A. amplifier, which is large enough to give a consider-

(Continued on page 374)



The radio hookup for the "talking and singing" canary.

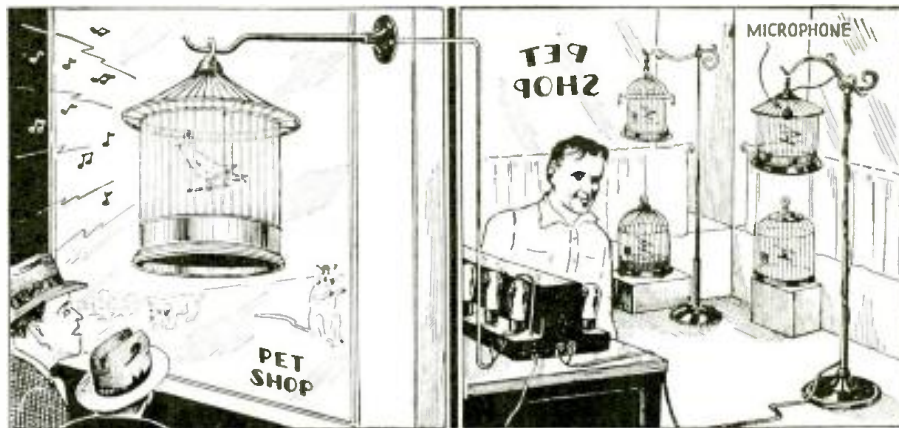

Making one canary sound like the entire Canary Islands!

HOW TO MAKE A REAL VELOCITY "MIKE"

H. G. CISIN

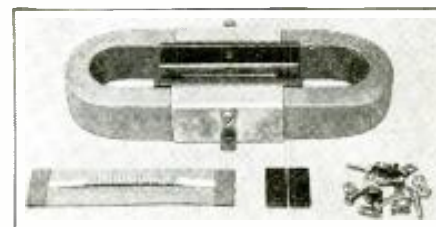

Fig. A
Components of the velocity mike kit.

THE velocity microphone is essentially a highly specialized form of electrical generator. Like any other generator, its principle of operation depends upon cutting a magnetic field by means of a closed conductor. In this way, varying electromotive forces are generated, which set up varying currents in the conductor. In the actual instrument, the conductor consists of a very thin corrugated aluminum alloy ribbon suspended in such a way that its slightest motion will cause it to cut across a strong magnetic field created by permanent or electro-magnets. Sound waves impinging on the ribbon cause it to vibrate. The ribbon forms a part of a closed circuit, being connected to the primary of an input transformer feeding into a two-stage pre-amplifier. Hence, the minute fluctuating e.m.f.s generated when the ribbon cuts the magnetic field, correspond exactly to the emitted sounds which caused the ribbon to vibrate. The result is the flow of a small fluctuating current

(Continued on page 373)

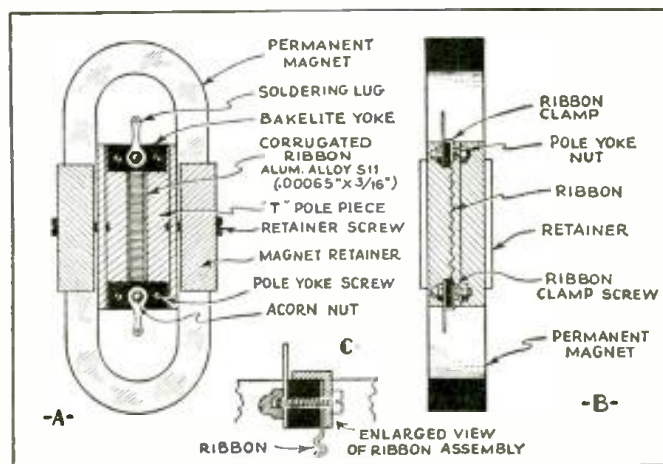

Fig. 1
Details in constructing the "velocity"-type microphone.

The RADIO MONTH in

NEW YORK RADIO SHOW

THE Radio Electrical Exposition in Madison Square Garden came to an auspicious ending on Saturday, September 30th, after having run for ten days, Sunday included. The show was a great success, it is claimed by the exhibitors, because more than 200,000 passed through its gates. According to the management, the show drew over \$1,500,000 in business for the exhibitors, and they are so heartened that they will run another show in 1934, to be held September 19th to 29th.

Loitering around the show, the editor tripped over dozens of refrigerators in his search for radio sets. It was a grand show for refrigerators and, once in a while, he could discern in the offing some radio sets. The only thing that was missing was a combination refrigerator and radio. The whole ground floor was at least 80% refrigerators, with 20% radio sets thrown in for good measure. This should not be considered a harsh criticism of the show, because it was not a Radio Show primarily, for the pure, unadulterated radio shows of former years had blown up; and the depression made it necessary to combine radio and electricity, which the exposition did successfully.

As far as we could find out, not a radio parts manufacturer was represented.



No, gentle reader, this combination radio refrigerator was NOT at the 1933 Radio Show. It may be there next year.



Tesla radio-controlled airplanes will bomb tornadoes out of business.

TESLA TAMES TORNADOES

AND now comes the veteran 79-year-old scientist, Nikola Tesla, the world's greatest living inventor, who says that he has found means to tame the tornado, which annually takes toll of thousands of human lives, not to speak of the millions of dollars of property damage.

Paying a visit to Hugo Gernsback, editor of this publication, the other day, Dr. Tesla disclosed his plan which, by the way, is published with a great many illustrations along with his original article, in the December issue of *EVERY-DAY SCIENCE AND MECHANICS* magazine.

Tall, gaunt, and sparse, the ascetic great inventor retains a keen interest in applied science. His recommendation, in a few words, is to use radio-controlled robot airplanes, which can be controlled from the ground. The airplane is sent up and directed straight toward the funnel of the tornado as soon as one is reported. Should a tornado start at sea, the same thing can be accomplished by Government patrol ships, which will dispatch radio-controlled robot airplanes toward. The trick, according to Dr. Tesla, is to drop a huge charge of explosives right into the mouth of the tornado funnel. This is to be accomplished by distant

watchers, who spot the airplane when it is directly above the funnel and release by radio impulse an explosive charge which, dropping into the funnel, destroys the whirling vacuum of the tornado and stops its progress before further damage can be done.

ARMSTRONG REGENERATED

EVERY radio fan worth his salt knows what regeneration means. It means additional power, more sensitivity, to radio sets. Short-wave fans, particularly, cannot do without regeneration. But who is the inventor of regeneration?

Last month, the now totally bald, but youngish looking Edwin H. Armstrong walked in on the editor of this publication. For the first time in 12 years he smiled. For the first time in a dozen years he consented to talk about a sacred and taboo subject—Regeneration. Reason: there has been a 12-year battle about it between Dr. Lee deForest, the inventor of the 3-element vacuum tube and Major Edwin H. Armstrong. Recently, the U. S. Court of Appeals for the Second Circuit handed down its verdict, making Armstrong* the sole and undisputed inventor of regeneration.

Armstrong showed that he first invented regeneration in the year 1913, and he conclusively seems to prove now, that he and not deForest is the real inventor. Of course, the Supreme Court has not as yet rendered its verdict, and on the other hand, the controversy may never go to the Supreme Court.

The radio fraternity will now arise *en masse* and shout congratulations.

*The decision was rendered in favor of the Radio Engineering Laboratories, Inc., against the Radio Corp. of America, A. T. & T. Co., and de Forest Radio Co.

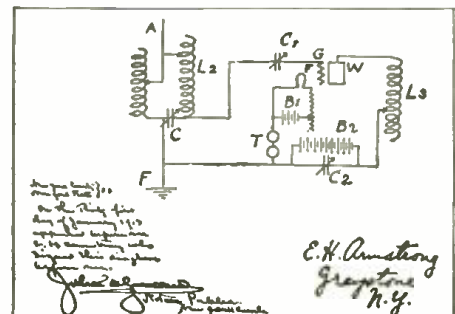

Armstrong's original regenerative circuit sketch, invented in 1913.

REVIEW



Ed Wynn the actor—and No. 3 Broadcast Chain originator.

ED WYNN CHAIN A DUD

WITH a great amount of fanfare and colorful noises at the headquarters of the newly-born Amalgamated Broadcasting System, the newest national broadcasting chain made its debut on September 25th. It is Ed Wynn's long-heralded "third chain." Most of the noise was made on the 11th floor of the vast A.B.S. quarters at Madison Ave. and 52nd St., New York. We say most of the noise and hullabaloo was in the broadcasting offices; because very little of the noise percolated into the ears of the chain's prospective listeners. We expect a real broadcasting chain to have millions of listeners, into whose ears the noise, or sound, will finally settle.

Alas and alack, the new A.B.S. chain is not destined to do so. The reason is that the chain is a chain in name only, and, from what we can see, it will never amount to much for some very simple and elementary reasons.

All of the stations, with the exception of two, are in trade parlance so-called "graveyard" stations; that is, they are so far down in the broadcasting spectrum, that broadcast listeners are unlikely to tune in any of them, even though Ed Wynn himself were to broadcast all day long—which he probably won't. Not only are all of the stations except two—WHDH, Boston and WLBZ Bangor—down in the graveyard, but they have no power either. All of them put together don't come anywhere near having half of the power of one such station as WABC, WJZ, WEAJ or WLW. Most of these stations cannot

be heard for more than 25 miles, if so far; and in congested districts like New York, Philadelphia and Washington, these "repeaters" on out of town station wavelengths can be heard only a few blocks. Heterodyning, they have birdy whistles, or a program of unintelligible hash.

The idea of a third chain is O.K. if the promoters had the stations; unfortunately, the chain has no stations to amount to anything and, when they talk of a "national outlet," as their high-pressure advertising department no doubt will, it will be found that the outlet is not functioning. The only people

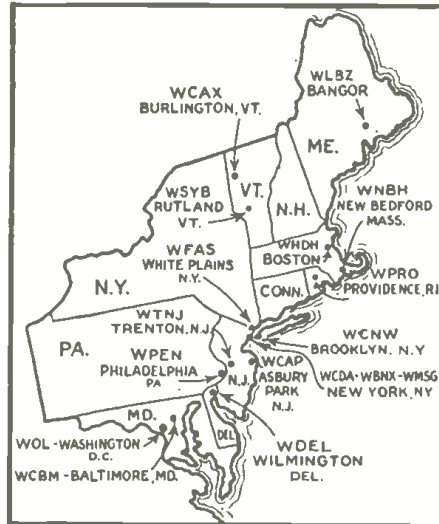

Territory embraced by the Amalgamated Broadcast System.

who will listen to the emissions will be the advertisers; and, in our opinion, as former owners of a fairly decent broadcast station, the advertisers will not get results.

With no exception the A.B.S. goes to the identical cities now adequately served by National Broadcasting Co. and Columbia, where both veteran chains control good station outlets. A.B.S. covers no new territory, no new towns, performs no discernible service.

The new chain does not use American Telephone and Telegraph Co.'s phone lines to link together its out of town radio stations; instead it uses Western Union wire lines. Broadcasters have tried this cheaper method time and again, but have found out that they are noisy and can't be properly balanced. Broadcast engineers in the know never use them except in dire emergency.

If the third chain is simply a scheme to sell stock, it may succeed in this, but the poor investors will be stuck, as usual.

Radio is now such a vast and diversified art it has become necessary to make a general survey of important monthly developments throughout the field. RADIO-CRAFT analyzes these developments, and presents here a review of those items which are of interest to all.

We have all sorts of respect for Mr. Ed Wynn as a comedian but, as a broadcaster, we believe he has pulled a serious boner, and has been deluded by promoters.

STATIONS OF THE AMALGAMATED CHAIN

| Call | Location | Power (Watt-) | Wave-length (Meters) |
|------|---------------------|---------------|----------------------|
| WLBZ | Bangor, Me. | 500 | 484 |
| WNBH | New Bedford, Mass. | 100 | 229 |
| WOL | Washington, D. C. | 100 | 247.9 |
| WPHN | Philadelphia, Pa. | 100 | 200 |
| WPRO | Providence, R. I. | 100 | 247.9 |
| WSAR | Fall River, Mass. | 250 | 206.9 |
| WSYB | Rutland, Vt. | 100 | 200 |
| WTNJ | Trenton, N. J. | 500 | 234.4 |
| WCBM | Baltimore, Md. | 100 | 219 |
| WCAJ | Asbury Park, N. J. | 500 | 234.4 |
| WCAJ | Burlington, Vt. | 100 | 250 |
| WCAJ | White Plains, N. Y. | 100 | 247.9 |
| WCBM | Brooklyn, N. Y. | 100 | 199.9 |
| WDEL | Wilmington, Del. | 250 | 267.9 |
| WFDL | White Plains, N. Y. | 100 | 247.9 |
| WHDH | Boston, Mass. | 1000 | 361 |
| WLBZ | Bangor, Me. | 500 | 484 |
| WNBH | New Bedford, Mass. | 100 | 229 |
| WOL | Washington, D. C. | 100 | 247.9 |
| WPHN | Philadelphia, Pa. | 100 | 200 |
| WPRO | Providence, R. I. | 100 | 247.9 |
| WSAR | Fall River, Mass. | 250 | 206.9 |
| WSYB | Rutland, Vt. | 100 | 200 |
| WTNJ | Trenton, N. J. | 500 | 234.4 |

MARCONI IN THE UNITED STATES

MARCONI returned to the United States, last month, on a special invitation to the Century of Progress in (Continued on page 357)



(International News)

Senatore Marchese Guglielmo Marconi and his wife as they appeared on landing in New York.

RECENT RADIO DEVELOPMENTS— —ILLUSTRATED

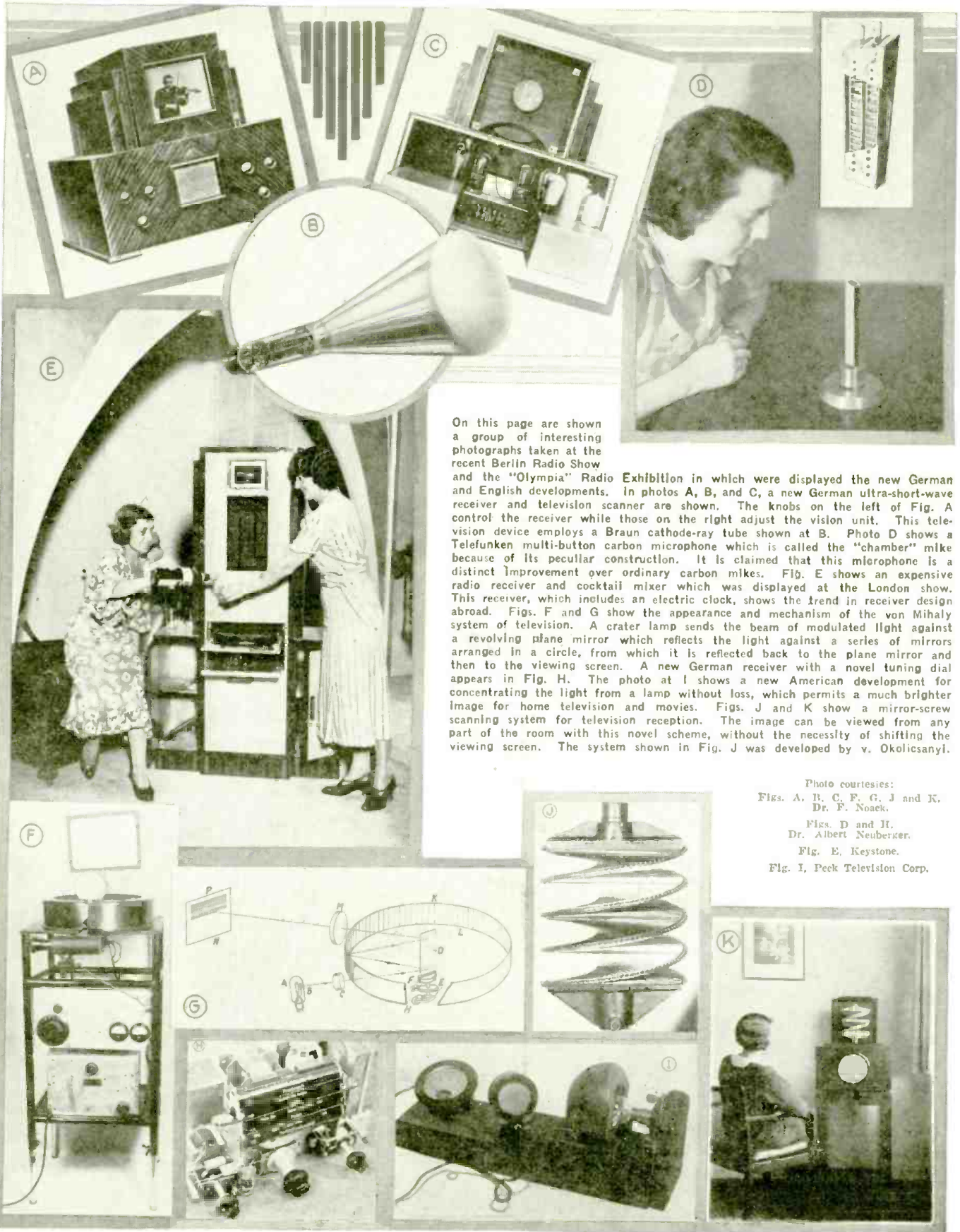

On this page are shown a group of interesting photographs taken at the recent Berlin Radio Show and the "Olympia" Radio Exhibition in which were displayed the new German and English developments. In photos A, B, and C, a new German ultra-short-wave receiver and television scanner are shown. The knobs on the left of Fig. A control the receiver while those on the right adjust the vision unit. This television device employs a Braun cathode-ray tube shown at B. Photo D shows a Telefunken multi-button carbon microphone which is called the "chamber" mike because of its peculiar construction. It is claimed that this microphone is a distinct improvement over ordinary carbon mikes. Fig. E shows an expensive radio receiver and cocktail mixer which was displayed at the London show. This receiver, which includes an electric clock, shows the trend in receiver design abroad. Figs. F and G show the appearance and mechanism of the von Mihaly system of television. A crater lamp sends the beam of modulated light against a revolving plane mirror which reflects the light against a series of mirrors arranged in a circle, from which it is reflected back to the plane mirror and then to the viewing screen. A new German receiver with a novel tuning dial appears in Fig. H. The photo at I shows a new American development for concentrating the light from a lamp without loss, which permits a much brighter image for home television and movies. Figs. J and K show a mirror-screw scanning system for television reception. The image can be viewed from any part of the room with this novel scheme, without the necessity of shifting the viewing screen. The system shown in Fig. J was developed by v. Okolicsanyi.

Photo courtesies:
Figs. A, B, C, F, G, J and K,
Dr. F. Noack.
Figs. D and H,
Dr. Albert Neuberger.
Fig. E, Keystone.
Fig. I, Peck Television Corp.

"ELIZABETH AIR RADIO"

Exclusive Photos of the First Dial-Type Remote Controlled Air Beacon to Use Flight and Landing Beams with Both Aural and Visual Signals to Make Flying Safe.

The photos on this page show the mechanism at the Elizabeth (N. J.) beacon station for the Newark (N. J.) Airport. The four half-wave antennas (above) radiate "courses" in four predetermined directions. The 'phone dial at the left, controls the entire system by a series of number combinations. The pilot receives TWO signals; the visual one consists of a device with two white vibrating reeds shown directly below, which move up and down to indicate "on" or "off" course. The aural one consists of phones or speaker in the plane cockpit; a dash indicates "on" course, a "dot-dash" left of course, and "dash-dot" right of course. Weather reports received by teletype are transmitted to pilots by voice.

Above, the Newark control panel from which communication is handled by dial telephone.

Left, teletype machines and, above, a weather report being "spotted" onto a printed map.

Course code sending device.

The automatic transmitters.

Courtesy U. S. Dept. of Commerce. Photos by Halbran.

NOW, AS PREDICTED—A POCKET.

NOVEL DESIGN FEATURES

Only two tubes, but what performance! Local stations at "room" volume, using only an indoor antenna! And the entire set fits your pocket!

The following examples of skillful PRODUCTION design are given: four-capacity bypass condensers of high value and no thicker than a pencil; a two-gang tuning condenser only three-eighths inch thick; a magnetic reproducer equipped with the smallest molded cone ever designed. The design and production engineers next worked out an original and compact assembly of these units.

However, in the first analysis, exceptional credit must be given to the tubes and unit used. Here it is that every artifice has been used to secure from the tubes the greatest amplification of which they are capable. Essentially a T.R.F. circuit, the diagram, reproduced below, presents many novel features and possibilities.

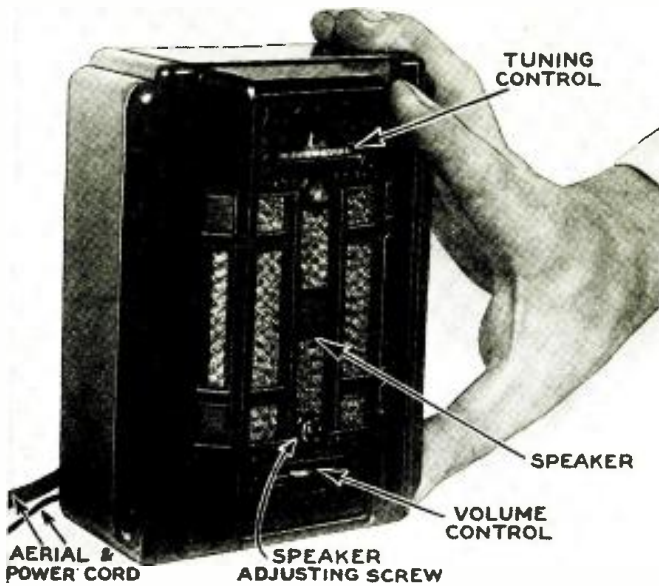

Fig. A
Music in the palm of your hand!

ONCE again the manufacturer of the now famous International "Kadette" receiver has achieved a "scoop" over the remainder of the radio manufacturing industry. When the original Kadette receiver was produced, making possible universal operation of a receiver, mounted in a small bakelite cabinet, little more than a hand full, the radio industry gasped, and immediately set about copying the design. Those who read the original article describing this receiver which appeared in the February, 1933 issue of *RADIO-CRAFT* on page 464, will remember what a sensation it produced. The fact that this receiver could be operated from either the A.C. or D.C. power lines, without any changes made an immediate hit.

However, those of us who thought that the original Kadette receiver was the ultimate in small receiver design have another surprise awaiting us in the first view of this new "pocket receiver."

The cabinet measures 6 x 4½ x 2⅝ ins. and encloses the complete receiver, including the speaker, A.C. and D.C. universal power supply and the aerial. As this receiver weighs only 2 lbs., it can easily be slipped into an overnight bag or even into a coat pocket. The cabinets are furnished in a number of attractive colors.

The Circuit

The receiver employs two tubes, one of which is the 6F7, familiar to readers of *RADIO-CRAFT*; and a 12A7, which is a tube specially designed for this set. A study of the circuit diagram shown in Fig. 1 will reveal the action which permits loudspeaker reproduction with only two tubes.

The signals picked up in the aerial are fed through condenser C6 to the first tuned circuit, consisting of coupler L1 and condenser C1. From there the signals enter the control-grid of the 6F7

tube and are amplified in the "screen-grid" section of this tube. From there, the signals pass to the primary coil of coupler L2 which is tuned by condenser C2 and fed into the grid of the "triode" section of the 6F7.

Next the signals are fed to the control-grid of the 12A7 and are amplified in the pentode section of this tube. It will be noted that there is an extra cathode and plate in the 12A7 which serves the purpose of rectifying the power supply voltage when the set is connected to an A.C. line. Also, additional amplification is gained in the set by the unusual method with which the output circuits of the 6F7 are coupled to the 12A7.

The secret of the small size of this receiver is in the special two-gang tuning condensers C1 and C2. This special

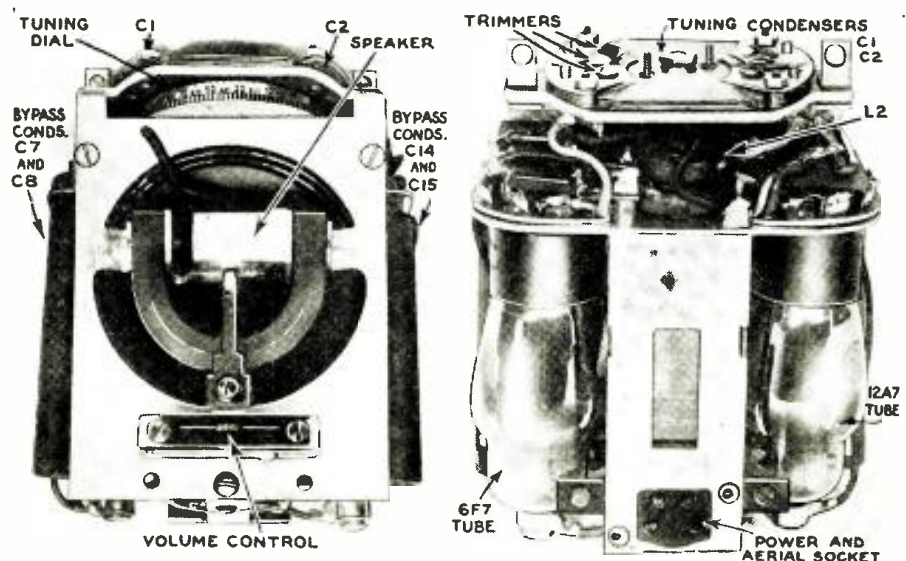

Fig. B
Front view of set.

Fig. C
The tubes and "works."

SIZE LOUDSPEAKER SET!

In February 1921, Mr. Hugo Gernsback published an editorial forecast entitled, "What is Coming." It has taken the radio industry over 12 years to catch up with one of his prophecies!

"At the aforementioned meeting," reads a partial quotation from the editorial, "the writer ventured the prediction that the radio business would settle down into much the same lines as the photograph business today. The chances are that during the next decade most of the radio apparatus will be sold by all up-to-date drug stores, the same as photographic cameras and supplies are today. **By that time a radio receiving outfit will have been compressed into a space as small as the present-day . . . pocket cameras . . .** These outfits will comprise a one- or two-step amplifier, and there will be no fones with such an outfit . . . The vacuum tubes in the output will be made . . . smaller."

For, it is only today that we find, in the "pocket-size loudspeaker set" described for the first time in this issue of RADIO-CRAFT, the **first real commercial radio set** built along the lines laid down so long ago.

Once again the radio industry has been "scooped" by the manufacturers of the "Kadette," first described in the February issue of RADIO - CRAFT!

condenser is shown in Fig. 2 and as you will note, it is a bakelite insulated unit, having a single set of rotor plates and two sets of stator plates. The entire unit measures $2\frac{1}{4} \times 3\frac{1}{2} \times \frac{3}{8}$ -in. thick. Old timers will recall seeing similar condensers back in the "good old days." Compared to the usual two-gang tuning condenser, it will be noted where the saving of space is accomplished. Aligning over the entire band is accomplished by the use of three screws and compressor "leaves" shown in Fig. 2.

In addition to the space saving features of the variable condensers, many other ingenious contrivances are used. Four by-pass condensers are compressed into small cylinders $3\frac{1}{4} \times \frac{3}{8}$ -in. in diameter. Two of these bypass units are employed. The tubes are suspended upside down in the chassis which is also of unusual construction.

Instead of the usual rotary type of variable resistor for controlling volume, a flat resistance strip with a slider is used. This may be seen in Fig. B, below the speaker unit.

The two R.F. coupling coils are only $\frac{3}{4}$ -in. in diameter by $\frac{3}{4}$ -in. high; they are "lattice wound" coils. Especially small size condensers and resistors are used for the various coupling and decoupling circuits while the voltage reducing resistor in series with the two tube filaments is incorporated in the

electric light cord, both to conserve space and to dissipate heat more readily.

The Operation

So much for the physical size of the receiver. In operation, the current is fed through the rectifier section of the 12A7 tube and for A.C. operation, the output of this rectifier is filtered by condensers and resistors. It will be noted that no filter chokes are used in the receiver due to the extremely compact design. This action is satisfactory for D.C., or operation on 60 cycles A.C. lines, but the receiver cannot be used with any great success on 25 cycle lines. However, since the latter lines are found only in certain isolated sections, this does not interfere greatly with the universal operation of the receiver. On D.C., the current is fed through the rectifier directly to the plates, grids and screen-grids of the tubes. In common with all A.C.-D.C. receivers, the plug must be inserted correctly in the socket for D.C. operation. This is necessary in order to place a positive potential on the plates.

The extremely small size and light weight of this receiver, service policy in connection with the earlier model Kadette.

The extremely small size and light weight of this receiver, combined with the low cost and the ability to mail it inexpensively and safely, make it an ideal gift item.

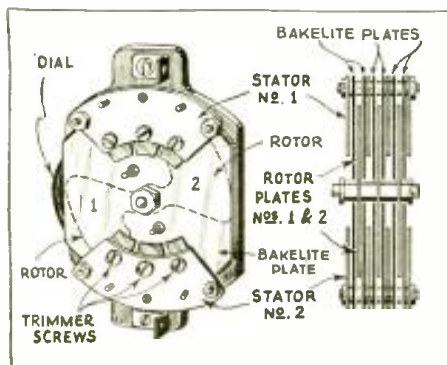

Fig. 2

The small-space 2-gang condenser.

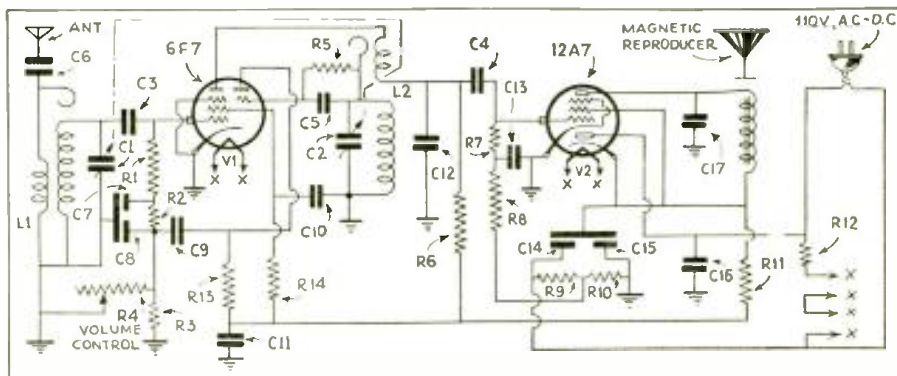
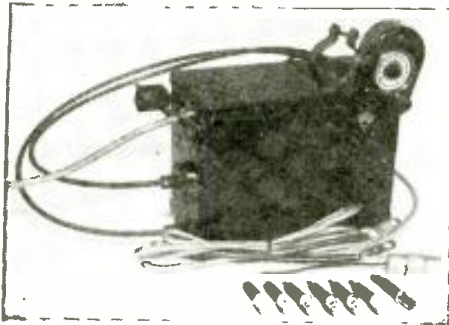

Fig. 1

Schematic circuit of the new, pocket-size T.R.F. set.

LATEST RADIO EQUIPMENT



Auto Radio Receiver (No. 156)

AUTO RADIO RECEIVER

The photo above shows the entire receiver (including power supply and speaker) which is housed in a metal case small enough to fit under the dash of any car.

The set is a superheterodyne, using a 6F7 as first detector and oscillator; a 78 as I.F. amplifier; a 75 as second-detector and A.V.C.; a 41 pentode in the A.F. circuit and a 6Z4 full-wave rectifier in the "B" supply circuit.



P.A. Amplifier System (No. 158)

RACK AND PANEL P.A. SYSTEM

This view shows a compact rack and panel P.A. installation, including an input control mixing panel, a superheterodyne tuner, a phonograph pickup and turntable and the actual P.A. amplifier. Any one or all of these individual panels can be easily removed from the rack for transportation or remote use. The entire installation measures 38 x 19 x 12 ins. deep.

A novel circuit design, described in recent issues of RADIO-CRAFT, permits every piece of equipment to be operated from either 110 V., A.C. or 6 V., D.C., which doubles their usefulness.

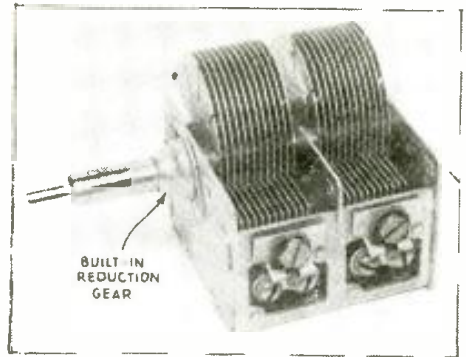

Novel Variable Condenser (No. 160)

"PLANETARY DRIVE" CONDENSERS

The condenser shown here has an unusual type of shaft which permits vernier control, by simply turning the smaller portion. This vernier drive consists of two concentric shafts, the inner of which is $\frac{1}{4}$ -in. and the larger $\frac{3}{8}$ -in. in diameter. Separate knobs are needed to utilize both the vernier and direct drives. The ratio is 3 to 1.

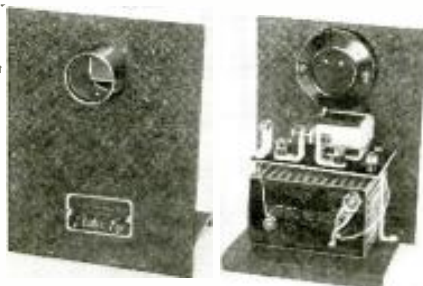

Photocell Unit (No. 157)

THE ELECTRIC EYE

This photocell unit, comprising a dry-disc type photocell, a small 22½ V. battery and a relay, all mounted on a black crystalline finished metal panel and chassis, has two outstanding features. They are its simplicity and low cost.

The complete unit can be housed in a box 5 x 6½ x 3½ ins. deep, inside dimensions.

When used in conjunction with a suitable lamp, the unit can be used for many "light controlled" experiments and tasks, including the control of lights, bells, doors, fire alarms, burglar alarms, advertising and window signs, traffic signals, and to count articles (as on an assembly line in a factory), provide remote measurements of liquids in a gauge and to test the density of liquids, such as lubricating oils.

This unit should find many useful tasks in the shop of the experimenter and in the hands of the radio technician.

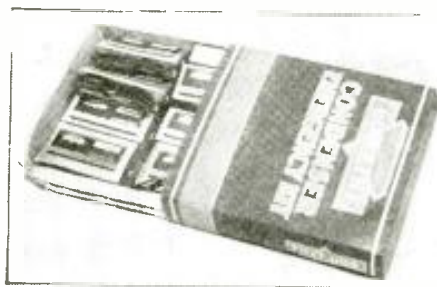

Emergency Condenser Kit (No. 159)

A SERVICE MEN'S CONDENSER KIT

A well known condenser manufacturer has just introduced this emergency condenser kit for the convenience of Service Men. It contains 10 condensers, 2 each of the following capacities—1 mf., 2 mf., 4 mf., 6 mf., and 8 mf. All of these condensers are rated at 600 V. maximum surge voltage.

By combining the capacities of this kit, the Service Man can replace practically any broken down condenser in a receiver.

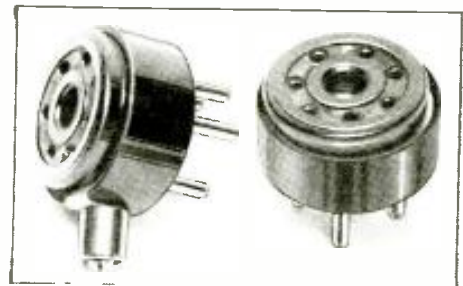

Two New Tester Adapters (No. 161)

12 V. FILAMENT ADAPTERS

Above are shown two adapter units that should prove extremely valuable to the Service Man.

The purpose of both adapters is to permit the testing of 12.6 V. tubes in tube testers which are not equipped to supply this voltage. These tubes are tested in the 6.3 V. socket, by connecting the tube filaments in parallel.

The adapter equipped with the control grid stud is used to check the 12A5 in the type 38 tube socket.

The other adapter is used for testing the 12Z5 tubes which are inserted in the type 37 or 84 tube socket in the tester.

These adapter units fill a need that is growing every day, as these tubes become more popular. It eliminates the necessity of purchasing a new tube tester, or making extensive changes in an available one. The units are small in size and "worth their weight in tube testers" when needed.

Name of manufacturer of any device will be sent on receipt of a self-addressed, stamped envelope. Kindly give (number) in description under picture.

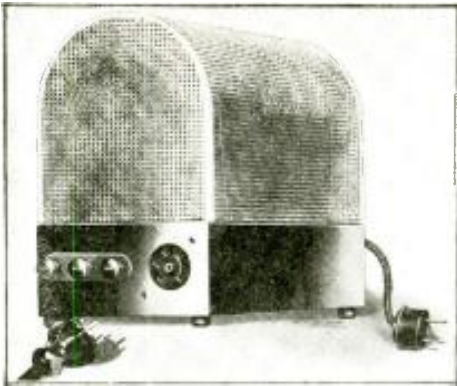

Condenser Mike Power Unit (No. 162)

CONDENSER MIKE EXCITER

Everyone familiar with microphones knows the high quality characteristics of the condenser "mike." The greatest difficulty in the use of this type microphone has been the bulk and weight of the batteries required to actuate the "head amplifier."

A manufacturer familiar to all microphone users has recently introduced a power unit that will do away with these heavy, bulky batteries.

This unit is $4\frac{1}{2}$ x 7 x 8 ins. long and weighs only 12 lbs. compared to the weight of 24 lbs. for the lightest corresponding battery complement. This unit supplies both the filament and plate current for two 30 type tubes with filaments in series.

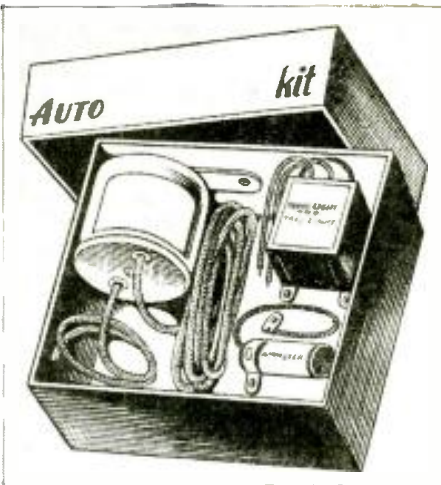

Auto Radio Noise Filter (No. 163)

AUTO RADIO NOISE FILTER

A firm which specializes in noise elimination has just brought out a kit of eliminators for car radio installations.

In mounting the kit, the lead from the aerial to the receiver is shielded; it has been found that much noise in sets is due to the proximity of the aerial to the dome light or tail light and these are also filtered. The filter on the battery lines prevents disturbances in these wires from entering the set and a filter at the ammeter prevents the circulation of noises through the car wiring.

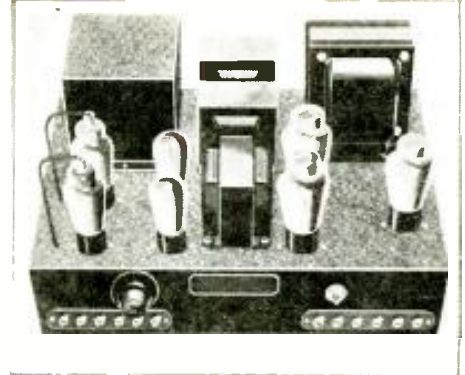

Class A Prime Amplifier (No. 164)

CLASS A PRIME P.A. AMPLIFIER

This P. A. amplifier uses a three stage triple push-pull, double class A prime circuit. In the first stage, two 57 tubes are used in a push-pull arrangement. These are bridge coupled to a pair of 56 tubes, operated in push-pull class A prime. A special class A prime input transformer is connected between the second stage and the output stage. The latter employs the new 2A3 tubes, also in class A prime. A 5Z3 full wave rectifier supplies the plate current for all tubes.

The power output of this amplifier is 15 W. with a maximum gain of 88 db., attained at 1,000 cycles. A multi-tap input transformer in the amplifier matches it to mikes or a phono. pickup.

A 5-UNIT RADIO TESTER FOR COMPLETE SET ANALYSIS

BEFORE the advent of this tester, Service Men operating with moderate priced testers were obliged to carry a number of instruments in order to handle the average run of routine service calls. A cartoon which appeared in the September 1933 issue of RADIO-CRAFT illustrated this point most thoroughly. It showed the hard-working radio man going out on a 50c service call, his car loaded up with analyzers and meters. Lacking sufficient room in his old bus, he was obliged to use a trailer in order to bring along the rest of the testing equipment needed to take care of the job!

Admitting that this cartoon presented an exaggerated picture of actual conditions, it certainly presents a forcible plea for fewer and more effective radio testers.

With the "Five-Unit Tester," however, life again becomes less complicated for the radio Service Man. For here is an instrument which combines every one of the five units urgently needed in modern servicing. These include an analyzer unit employing the "Free Reference Point" system; a tube tester using the same system and employing the accurate grid bias shift method; an oscillator of the selective frequency type

with eleven fundamental frequencies each made available through an eleven-point rotary switch; a capacity meter which covers the entire field of service testing and with all readings plainly indicated on an evenly-divided meter scale, and finally an ohmmeter having three ranges 0-1,000; 10,000; 100,000 all operated by a self-contained 4.5 V. battery with an additional range of 0-1 meg., made available by connecting an external 45 V. battery to the jacks provided for this purpose.

(Continued on page 370)



Fig. A

The appearance of the tester (No. 165)

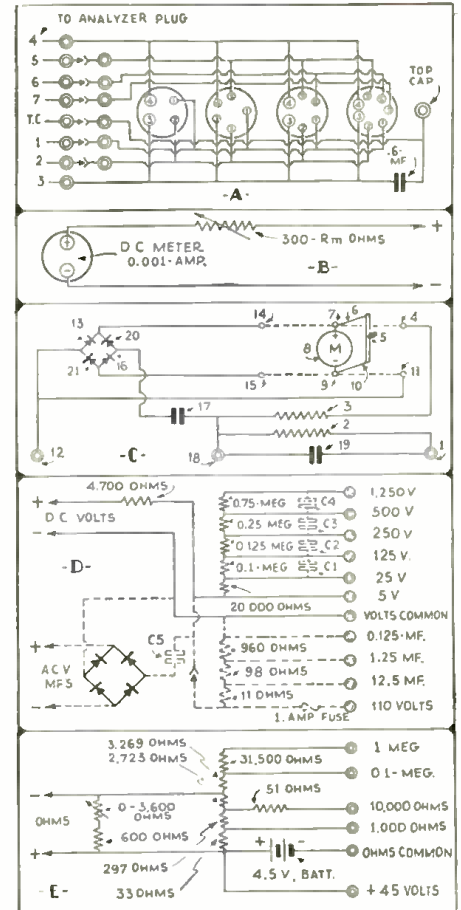

Fig. 2

Circuit diagrams of the five units.

A SUPER-POWER AND-QUALITY P.A. SYSTEM

A 46-tube system designed for addressing an audience of 20,000 people! Cost? A mere \$100,000!

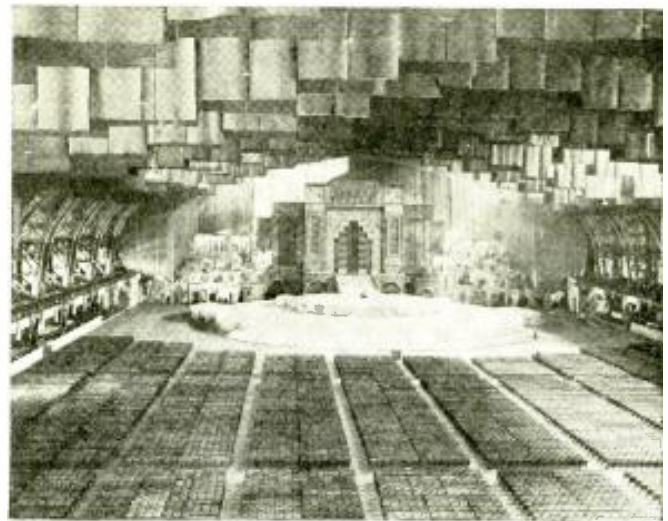

Fig. A
The sound system "all set" to address 20,000 people.

C. W. PALMER

PART I

IN PRESENTING "The Romance of a People," a pageant which recently appeared in New York depicting the history of the Hebrew race, many difficult problems had to be solved in projecting the music and voices throughout the enormous auditorium. To show just how difficult these problems were, a picture of the interior of Kingsbridge Armory, the largest in the world, is shown in Fig. A.

Over 6,200 persons comprised the cast in this pageant, and at the opening night, an audience of 20,000 people attended!

The usual drab drill hall of the Armory was transformed into a modern theatre of huge dimensions. This change was accomplished in six days by a corps of 1,000 workmen who worked day and night.

To obtain satisfactory "coverage" of the tremendous audience (About 8 times the size of an average theatre audience!) required the use of a super-power P.A. system about 10 times as powerful as an ordinary "high power" amplifier! Actually, a new electro-acoustical sound system, with an unusually flat frequency characteristic, running from 16 cycles per second to about 20,000 cycles, was developed by a well-known engineering company for the purpose. (Subsequently, the system will be installed in a mid-west church.) The cost of the ap-

paratus used in the installation totalled over \$100,000. While this P.A. system is complicated in its design, being made for an unusually high output, there are many features that will be of interest to the radio experimenter and Service Man.

Initial Considerations

Two distinct amplifier systems with their speaker units
(Continued on page 360)

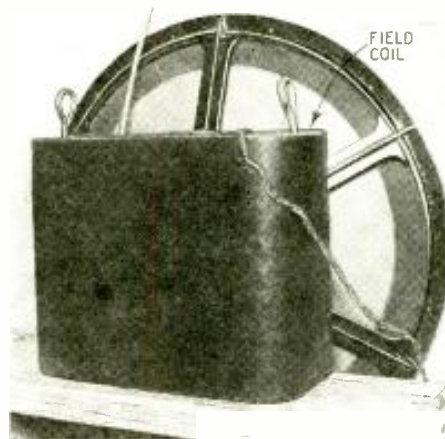

Fig. B

A 20-inch dynamic speaker. with A 4 1/2 inch voice coil!

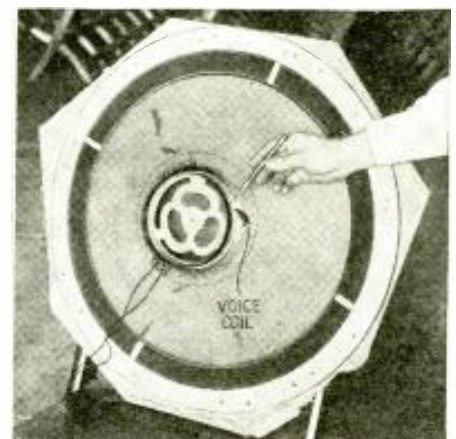

Fig. C



Fig. D

A front view of the complete speaker set-up. The "baffle" actually measures about 50 x 70 feet high! About 20 (assorted) reproducers are shown.

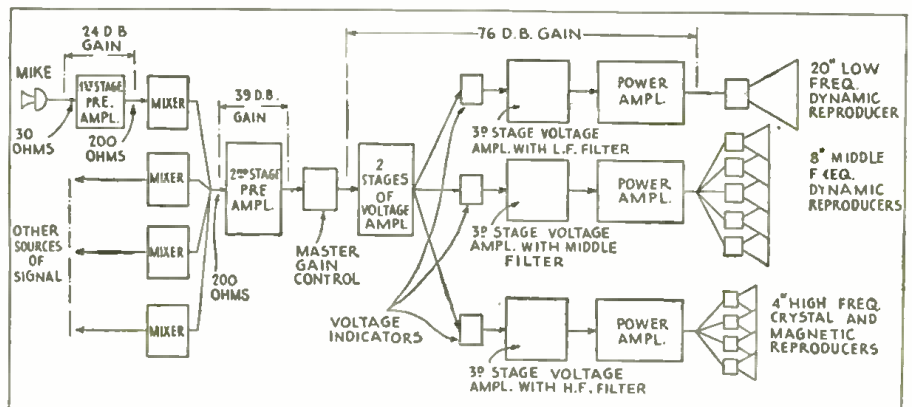

Fig. 1

A "block" illustration of the complete sound installation.

INTERNATIONAL RADIO REVIEW

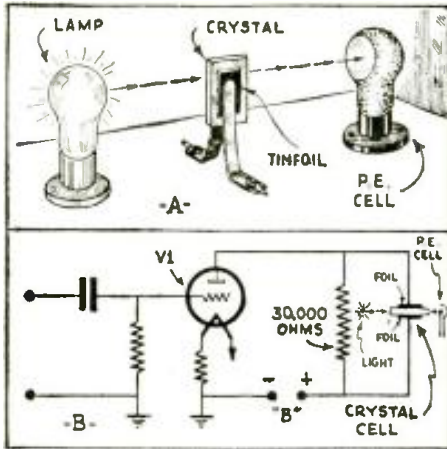

Fig. 2
New use of zinc sulphite crystals.

TRANSFORMERLESS OPERATION WITH 220 V. FILAMENT TUBES

THE accompanying illustration, Fig. 1, shows a receiver circuit that was designed for use with the Ostar Ganz high-voltage filament tubes available in Europe.

These tubes, which are made in a number of different types, including triodes, screen grid tubes, pentodes, etc., are similar in construction to the ordinary heater type tubes, except for the filament which is designed to operate directly from the A.C. or D.C. power lines, without any voltage dropping resistors or transformers.

The result is a much simplified construction, as the diagram shows. This particular set was designed for universal operation on either 220 V., A.C. or D.C. and for this reason, the rectifier V4 was

HERE is what the radio experimenter has been wanting for a long time—a semi-technical review of the thousands of new ideas which are continually appearing in overseas publications. Each month there are received at the offices of RADIO-CRAFT hundreds of daily, weekly and monthly magazines originating from every point on the face of the globe.

SINCE the cost of subscribing to each of these would be prohibitive for most radio men, we have arranged with technical translators to prepare for our readers reviews of all the really important, new developments illustrated and described each month in these international radio periodicals.

NOTE that the only available information is that which is published; the experimenter must adapt the ideas to whatever equipment he has on hand.

included. For D.C. operation, the circuit is even more simple.

The photograph, Fig. A, shows one of the Ostar Ganz tubes. It will be noticed that instead of using a tube shield, or spraying the glass envelope with molten metal, a wire gauze is used to effect a shield.

These tubes are creating some interest in Europe where they can be purchased. They are not available in the U.S.

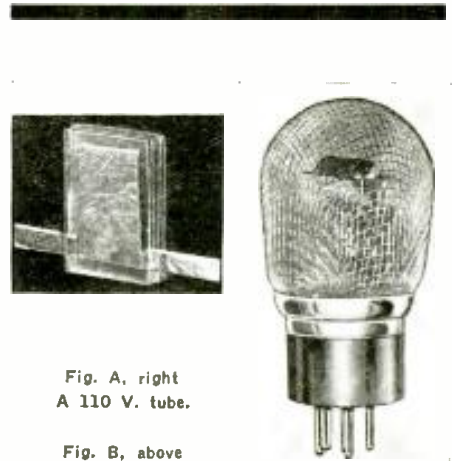

Fig. A, right
A 110 V. tube.

Fig. B, above
Crystal "shutter."

A TELEVISION "LIGHT MODULATOR"

THE ideal system for television reception is a light source of high efficiency, that is easy to modulate, gives pure white light and has a truly linear frequency characteristic. Further, it must not have any lag, even at frequencies running up into six figures.

AMATEUR WIRELESS, an English publication, recently published the results of some experiments which have come closer to the above ideal than any other, to date.

Von Okolicsanyi, the well known Hungarian television inventor, who is best known for his mirror-screw scanner, is the inventor of this new system. Okolicsanyi conducted his work among the inorganic crystals in his search for the ideal light modulator, he tested these for electrical double refraction. This effect is known to occur to some

(Continued on page 360)

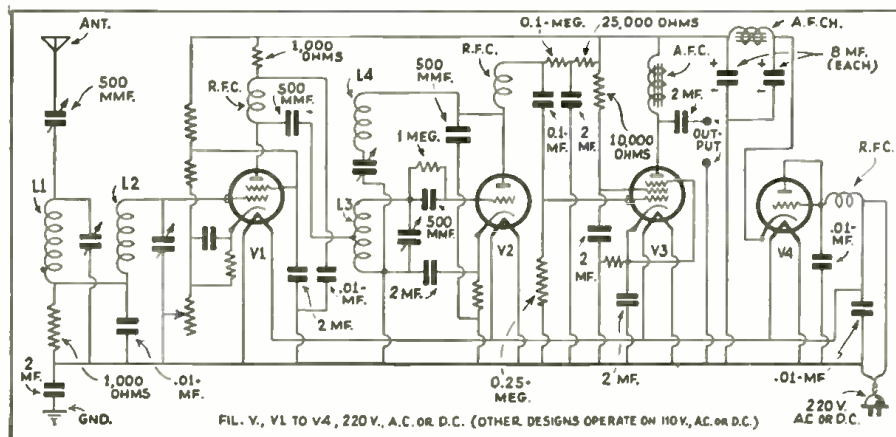

Fig. 1

The new tubes in this circuit operate directly from a 110 V. or 220 V. power supply.

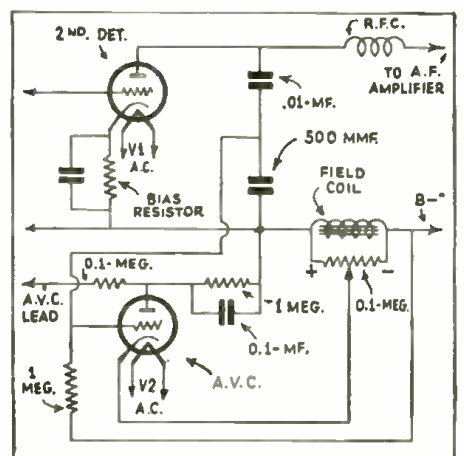

Fig. 3

A novel "C" bias connection.

HOW TO MAKE A MODERN CAR RADIO SET

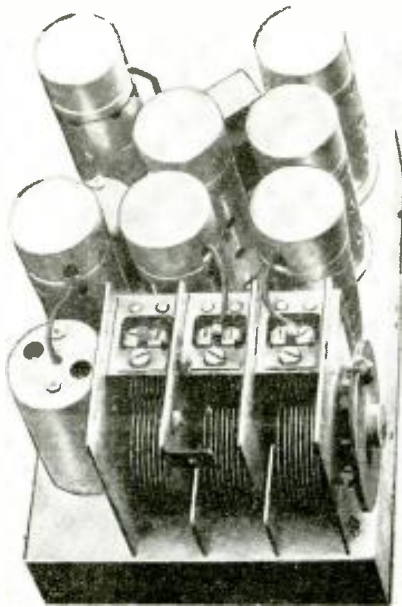

Fig. A
One model of the car radio.

This 7-tube set incorporates the new tubes, A.V.C., remote control, push-pull, A.F. output, and tone control in a compact chassis. Past issues of RADIO-CRAFT have described many commercial and home-built automotive radio receivers, but this article is the first one to include such remarkably complete details. Part I properly discusses the mechanical details; the schematic circuit is analyzed in Part II, to follow.

PART I XXXXXXXXXX HEINZ A. MUELLER

WHEN designing this 7 tube superheterodyne auto radio it was my endeavor to supply the radio constructor with all the information and drawings necessary to enable him to build a car radio receiver which will compete with the factory-built set.

The radio is designed for a floor mounting installation, which I believe is in most instances, preferable, as it is by all means the most rigid installation; rigidity being a main factor in auto radio construction. The design covers all the different features, and great stress is laid upon drawings; which makes the understanding much more simple than words can explain. The article gives full information on the wiring, both by general wiring and detail wiring diagrams; such as remote control, speaker and coil diagrams. All the parts which can be made by the constructor are fully specified on drawings with complete dimensions.

In constructing the radio set you will start with the chassis, part No. 1. The chassis is made of No. 16 gauge sheet steel. Drill all the holes as shown on the drawing. (See Fig. 1.) After drilling the chassis, bend the sides down and weld the joining corners of the chassis, thus making a very strong unit. It is advisable to have the chassis cadmium plated to prevent rusting and corrosion.

On the chassis drawing, Fig. 1, you will find two 11/64-in. diameter holes. These holes are provided to mount the chassis brackets, part No. 7, (Fig. 2A) in place. By means of 8-32 self-tapping screws these brackets are screwed to the chassis and serve to locate the chassis in the chassis box, which can be seen in Fig. 3. The brackets, part No 6, Fig. 2B, are provided for condenser mounting. Four of the brackets are assembled with the tuning condenser 2 1/4 ins.

apart and the condenser can be fastened to the chassis by using four 8-32 self-tapping screws, cutting the thread through the No. 31 (.120) holes on the brackets.

After completing the chassis you can proceed with mounting the parts to the chassis, and for this work you will be guided by the drawing, Fig. 4, showing a top view of the chassis assembly. Place the sockets and socket shield bases in position and fasten them to the chassis either by means of 6-32 round head screws, or by rivets. When placing the sockets, take care that they are located as specified on the drawing. Now, place the rubber grommets in the specified holes and also assemble the PM-7 contact terminal socket. The next operation is to mount the tuning condenser by means of a bracket assembled to the condenser with self-tapping screws. After these operations it will be wise to wire the heater wiring for the tubes. The next step will be the assembly of parts located inside of the chassis, for which work you will refer to Fig. 5. Place the antenna and radio frequency coils as shown on this drawing and fasten them to the chassis by means of 6-32 round head screws, nuts,

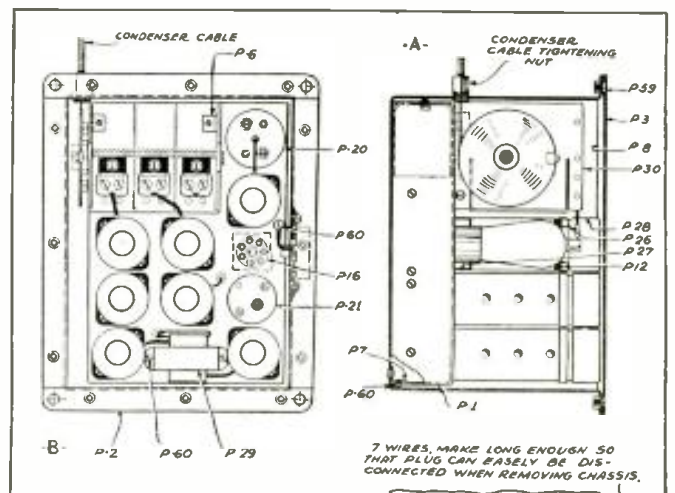
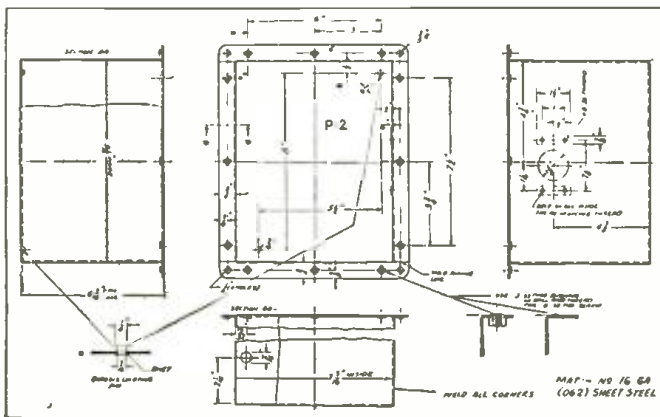
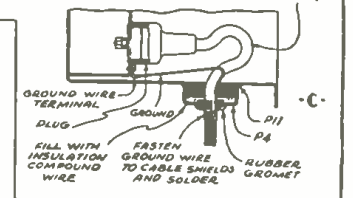

Fig. 3, above
Details of the miscellaneous mountings.

Fig. 7, left
Details of the sheet-steel, 16 ga. housing.



and lock washers. Similarly, mount the condensers in place in the cans using screws or rivets. On this drawing, Fig. 5, you will also see the resistor and condenser mounting brackets, part No. 15 (Fig. 6) in place, fastened to the chassis by means of 6-32 screws and nuts. These two brackets do not necessarily have to be used. However, when using them, a more rigid wiring can be produced by securing some of the resistors and small condensers with these brackets; fastening the terminals of resistors and condensers through the rivet holes of the brackets, soldering the connecting points and bringing one lead to the terminal as required by the wiring diagram. Mounting the resistors and condensers in bunches on these two brackets will make the wiring very solid, rigid and pleasing to view. In Fig. 5 you will also see the chassis brackets assembled in place as mentioned above.

Part No. 2 (Fig. 7) shows the chassis box built of No. 16 gauge (.062) sheet steel and finished either with cadmium plating or enameling. The drawing is self-explanatory. In one view is shown the chassis locating pin, two of which are required. Rivet them to the box so that the pin will extend inside of the box. The rim of the box is provided with twelve 8-32 bushings for tightening the chassis box cover. However, should you not have these threaded bushings handy, the threading for the 8-32 screws could be made directly in the box rim as shown on the drawing. On one side of the box a 1-5/16 in. diameter hole is provided as a cable entrance. The four holes with the 8-32 thread are provided to fasten the junction box to the chassis box. The threads for the junction box screws are reinforced by welding steel strips on the inside of the chassis box, also shown in Fig. 7.

The junction box shown as part No. 4 (Fig. 8) is also made of No. 16 gauge (.062) sheet steel, cadmium plated or enameling. All the cables going to the radio set are brought to this junction box. A rubber grommet is inserted in the 5/8-in. diameter hole and the wires brought through this grommet. Leave the length of all the wires about 5 ins. from the inside of this junction box to the end of the wire. All the cable shields which end at this junction box are tied together by a No. 14 copper wire soldered, and this same wire is then brought into the junction box and serves as ground wire with one end having a terminal clip fastened to the chassis by means of an 8-32 self-tapping screw. This is clearly shown in Fig. 3. After the assembly of the cables with the junction box is completed, fill the inside of the junction box with an insulation compound to prevent dampness or dirt from getting into the chassis box. All the wires going through this junction box will be connected to the type PM 7 contact plug, for which work Fig. 9 will guide you.

The terminals on this drawing are numbered with respect to the guide slot
(Continued on page 367)

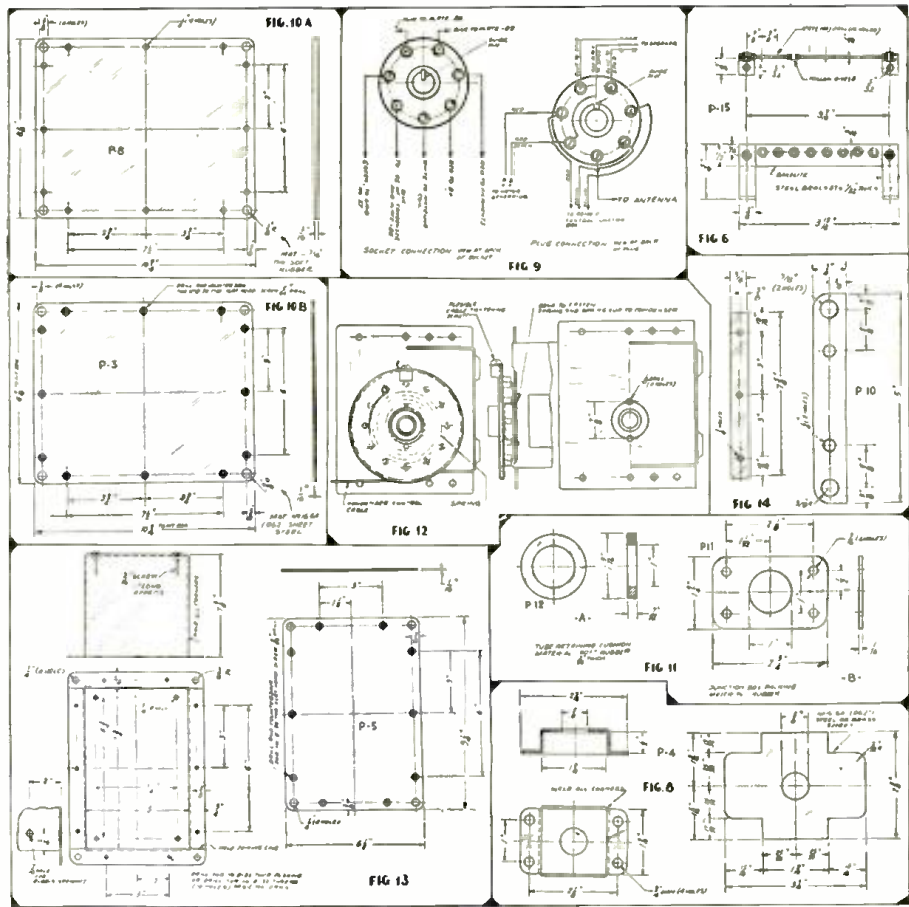

Figs. 6 and 8 to 13
Drilling, mounting and wiring details of the set.

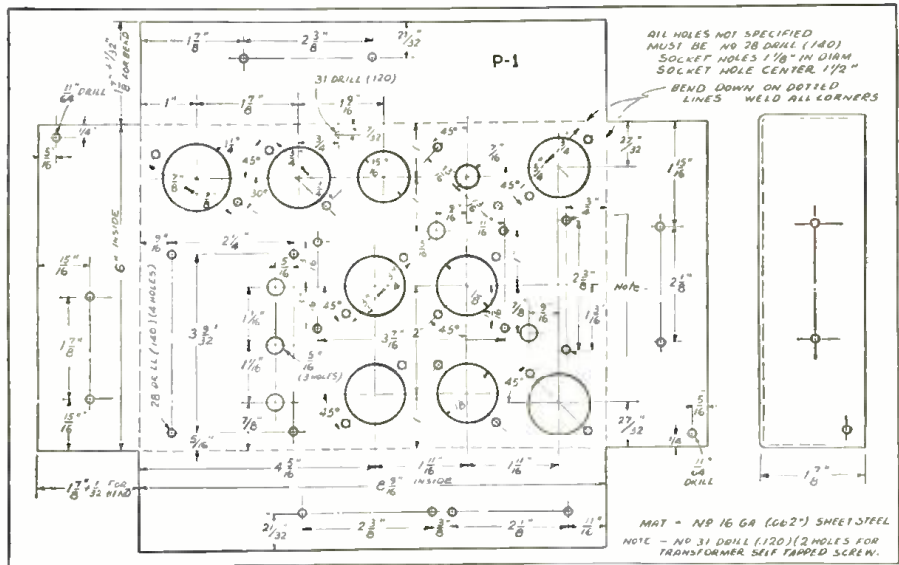
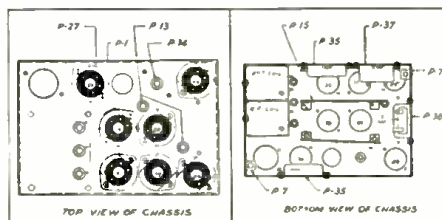

Fig. 1
Drilling specifications for the car radio receiver chassis.



Figs. 4 and 5
Left and right, top and inside views.

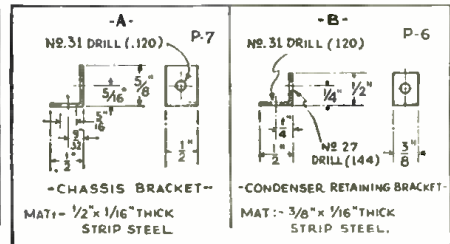

Fig. 2
Bracket-mounting details.

THE BEGINNER'S "UNIT CHASSIS" CRYSTAL AND 2-TUBE SUPERHET.

Previous "Beginner's" articles in RADIO-CRAFT have been devoted almost exclusively to the design of "bread-board" radio receivers. In the following article the author discusses further the "chassis-type" design which more closely follows standard radio set construction. The circuit has been changed to incorporate a superheterodyne connection.

PART III

FRANCIS R. HARRIS

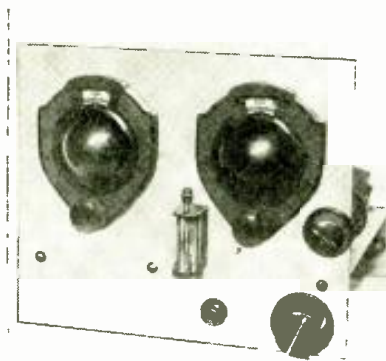

Fig. A
The front view of the "Superhet."

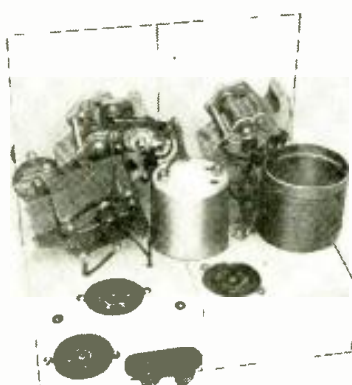

Fig. B
The rear view of the Beginner's set.

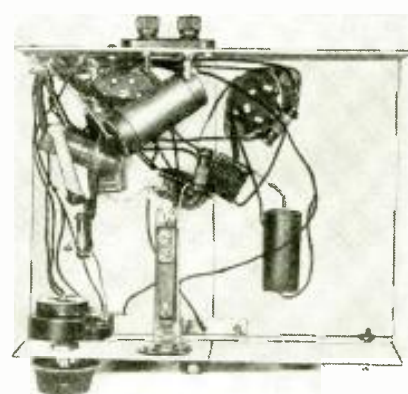

Fig. C
The under-side view, showing parts.

WHEN we started building chassis sets, two months ago, we promised that we would use the same construction for a number of layouts. The receiver this month, shown in Figs. A, B and C, is an example of this practice. With the same chassis, practically the same layout, and the addition of only one extra piece of equipment (which those of you who have followed the series, already have on hand) there results, not only a different set, but one operating on a totally different principle.

The heart of the circuit, shown in Fig. 1, and the thing which makes possible this result, is a new tube—the type 1A6. (This tube is described on page 267 of the November 1933 issue of RADIO-CRAFT.—*Technical Editor*).

In the September, 1933 issue of RADIO-CRAFT, on page 160, there was described in this department a crystal superheterodyne which made use of a tube oscillator, crystals as first- and second-detectors, and a tube audio frequency amplifier.

This set worked nicely, and demonstrated beautifully and simply the principle of the superheterodyne, but, due to the inefficiency of the crystal as a first-detector, it was rather low in sensitivity; a crystal first-detector constitutes a distinct loss in the circuit. In other words the voltage of the *intermediate* frequency or I.F. on the *output* side is considerably less than the voltage of the *signal* or R.F. on the *input* side.

The circuit shown here, on the other hand, due to the use of the new tube, gives a gain of approximately 40 in the "mixer" or "modulator" (sometimes called "converter") stage, which takes the place of the first-detector in the earlier circuit.

The Circuit

The circuit itself is very simple as will be seen by inspection of Fig. 1. The first stage consists of one type 1A6 tube which performs the double duty of mixer and oscillator—being in reality two tubes in a single bulb. The input R.F.

or signal voltage to the control-grid is tuned in by the tuned circuit L1, L2 and C2. The oscillator circuit consists of the tuned network L3, L4, L5 and C3, C4, C5, C6.

The mixing of the input and oscillator frequencies takes place in the 1A6 tube; and the plate output of this tube, into the intermediate frequency transformer L6, L7, is the result of this mixing.

The output of this transformer is fed into the grid of the type 33 audio tube through the crystal detector, thus the plate output of this tube is of audio frequency and is fed directly into the speaker or headphones.

The only part of this circuit which is unusual and may require explanation is the oscillator network mentioned above. This is what is known as a "padding" circuit. The requirement that the oscillator circuit tune at all times exactly 175 kc. away from the input R.F. (radio frequency) is met in superheterodyne circuits by either of two means. First, by a condenser having one section with specially cut plates or second, by means of this "padding" circuit. Of course, in our present set we are using two separate tuning condensers and padding is not strictly necessary, but in order to afford the beginner the opportunity to learn just how this padding is done, we are showing the circuit and describing the method.

Building

The layout of the set is shown very clearly in the photographs and, except for the addition of the intermediate transformer, which appears between the two tuning condensers, is practically the same as the previous receiver. The position formerly occupied by the type 34 B.F. tube is now occupied by the type 1A6, which means replacing the four-prong socket with one having six prongs. The wiring must, of course, be accordingly changed. The wiring of the type 33 output tube is practically the same as before; reference

to the two diagrams will show the changes necessary. Condensers C4, C5, and C6 must be mounted in a convenient place above the chassis so that they can be varied while the circuit is in operation.

No diagram is shown this time for the construction of the chassis themselves as full details were given in the November issue, to which the reader has been referred.

Operation

After the set is completely wired up and you are sure that everything is as it should be, plug in the tubes, attach the antenna and ground, and plug in the power cable plug. Then attach the "A" battery and turn on the filament switch. The tubes should light with a dull red glow. If this occurs, plug in the speaker or phones, attach the negative side of the "B" battery and flip the positive wire across its post. This should cause a moderately loud click in the speaker. If it does, the assumption is that the circuit is O.K. and the connection may be made permanent.

If a milliammeter is available, it may be inserted in the "B" circuit. The total current drain should be about 18 milliamperes.

Make sure that the little wire on the crystal detector is just barely making contact with the crystal. Turn the rotor, L4, of the oscillator coil to a position

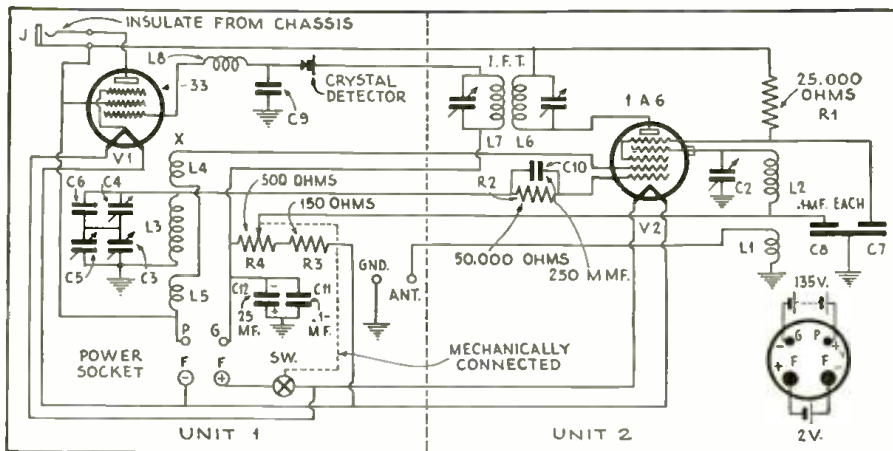

Fig. 1
The wiring of the two units; the battery cable plug is inserted into the "power socket."

where its axis is parallel with that of the main coil. Now try tuning for a signal, turning one condenser slowly while "rocking" the other one back and forth over a wide range. If no signal is heard, turn L4 through 180 degrees and try again.

It might be well, before doing the job, to approximately tune the intermediate frequency transformer by "feel," turning the two screws in the top of the can of I.F.T. until it takes about the same pressure to turn each one.

After a signal is picked up, which may require considerable patience, tune it in as loudly as possible with the two

tuning condensers, then turn the volume control until the signal can be just barely heard. Now, tune the intermediate frequency transformer, I.F.T., by turning the two screws until the best response is obtained. Without touching anything else, adjust the crystal detector to the loudest signal.

Make a note of each position of the two dials for this station—also its frequency—and then proceed to log as many more stations as possible, making a careful note of each one.

Now, we may proceed to "pad" the circuit; in other words, to make the two
(Continued on page 368)

The SCHOOLBOYS' 1-TUBE RECEIVER

Here is a real beginner's receiver—one that anyone can build, without having to know anything about either radio or mechanics. Just get a cigar box, a tube and a few other gadgets, and go to it. There's no time like the present!

ANY schoolboy can build this unique one-tube set and obtain really good reception at a trifling cost. It is an easy little set to make and will bring in plenty of stations on the headphones.

Apart from its low constructional cost, this set is very cheap to run. It works from a 45 V. "B" battery and takes so little current from the battery that it will last for at least six months and probably longer.

The basis of our one-tube set is the familiar cigar box. Any cigar store will have an empty one to give you—or perhaps your father will hurry up and finish his latest box of cigars, if you will tell him that you about to build something really useful for once!

One thing about the box; be sure that it is at least 2 in. deep, otherwise it will not hold all the parts. The box contains a tuning coil, a tuning condenser, detector tube and several smaller parts,

such as the grid leak, and a small semi-variable condenser for improving the aerial selectivity.

(Continued on page 369)

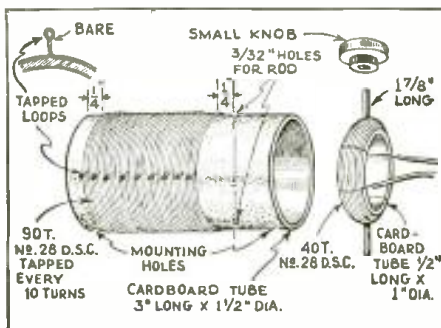

Fig. 2
Instructions for winding the tuning coil and regeneration (tickler) coil

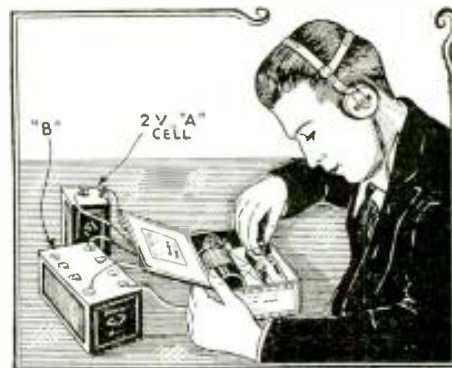

Fig. A
The complete receiver in the cigar box.

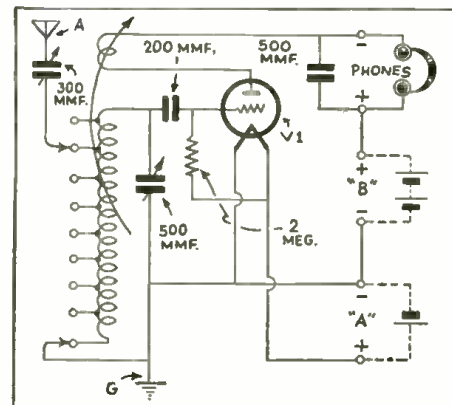

Fig. 1
The wiring diagram of the set—see also Fig. 3.

RADIO SHORT-CUTS

GAS-TORCH AND SOLDERING IRON HOLDER

Lowell E. Hinkle

The illustration in Fig. 1, shows a convenient and inexpensive torch and iron holder, that can be made by any one in a very short time. The burner used here is a Terrill laboratory burner and can be picked up most anywhere for a few cents. The iron holder is made from a scrap of heavy gauge galvanized sheet metal. This can be purchased at any roofing store. One 8-32 round head machine screw and nut are needed to clamp holder to burner and are also convenient for adjusting the position of the iron in the flame. This torch uses natural or artificial gas. It is not expensive to operate and can be regulated to keep the iron at the proper temperature. It is so small that it makes a good addition to any tool kit.

A HOME-MADE DRUM DIAL

Gernald Bates

Almost every radio experimenter has a collection of the old-fashioned plain four-inch dials on hand. With a little time and patience, it is surprisingly simple and easy to transform these into quite presentable and usable drum dials.

Usually it will be found that these plain dials are made in two sections. If one is careful, he can shatter the small corrugated handle portion with a couple of blows from a pair of pliers, leaving the numbered portion intact with its brass center shown in Fig. 2, A and B. At regular intervals around slightly more than half of the numbered portion, drill holes and mount four angle brackets made of aluminum (Fig. 2 C.) Cut

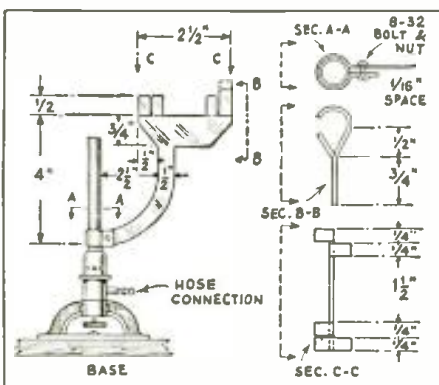

Fig. 1

Torch and iron holder details.

a strip of celluloid (heavy cardboard would do in a pinch) about an inch wide and bolt it to the outer brackets only, leaving the two center brackets to act merely as supports. Now the drum dial, shown in Fig. 2 D, of the "thumb" variety, is finished, ready for calibrating.

A pilot bulb may be mounted on the radio chassis behind the celluloid strip in such a manner that its light will shine through.

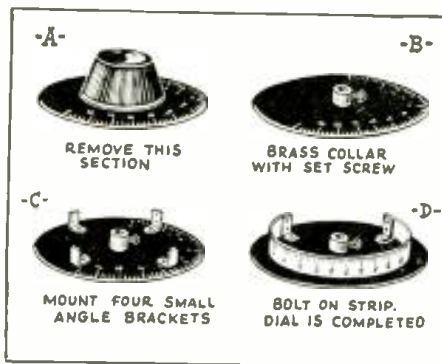

Fig. 2

A homemade drum dial. The construction is much more simple than the illustration indicates.

PLACING PARTS TO AVOID INTER-ACTING FIELDS

Arthur A. Walter

One of the greatest difficulties confronting the average custom-builder of amplifiers is in the avoidance of inter-acting electromagnetic fields. The usual method is to completely wire the amplifier and then, having left the iron-cored components unbolted from the base, change their relative positions until the least hum is heard in the speaker. Such a procedure makes the assembly of a compact job difficult, and at times, impossible. One never knows in what positions the components will eventually be placed or the space required for each component.

A method which has been applied to the building of many power amplifiers, and in "radios" in which this condition has been found, is as follows:—place the power transformer in the approximate position desired on the base and connect the primary to the A.C. power supply, leaving the secondary leads open. (Fig. 3.) Hook a pair of headphones across the filter choke terminals and place the

Hints, "kinks," ideas and suggestions that enable the amateur and professional to save time and money.

choke in the position desired near the transformer, moving it backward or forward, vertically or horizontally until a position of minimum hum is found. Oftentimes a movement of only 1/8-in. will suffice to change the sixty cycle current induced in the choke by the power transformer and heard in the headphones as a deep hum, to an absolute silence. A number of positions will be found in which no hum will occur. The choke and transformer may then be bolted in place and filter condensers, rectifiers, and bleeder resistances connected to form the power supply section.

To locate the correct position of the A.F. transformers, the headphones are connected across their secondaries and the above procedure followed with respect to both the power and the choke, the latter having acquired a field of its own after being connected to the rectifiers and line transformer and being able to induce a hum voltage of either 60 or 120 cycles to the audio transformer being located.

Incidentally, A.F. transformers will introduce distortion in a high-gain amplifier if their respective fields inter-act. This condition may also be corrected by the above method; the 110 V. line, however, being connected to the primary or secondary of one transformer and the headphones to the primary or secondary of the other. But, needless to say, first be certain that the primary or secondary of the transformer connected to the line has sufficient impedance to prevent being burned out by the line voltage.

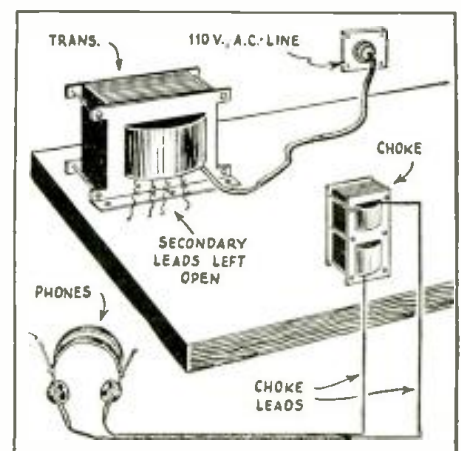

Fig. 3

"Hearing" stray fields.

READERS' DEPARTMENT

A department in which the reader may exchange his thoughts and ideas with other readers.

SERVICING "TALKIES"

Editor, RADIO-CRAFT:

In your current issue of RADIO-CRAFT is a statement to the effect that you are starting a series of articles on the servicing of Sound Motion Pictures.

We are a radio servicing organization in Cincinnati, and feel that this field offers an untouched source of revenue in the Cincinnati area. We will appreciate your aid in contacting independent manufacturers of replacement parts for sound motion pictures, and in obtaining any other information and assistance you can offer.

The writer has been in technical work with W.E. sound pictures and feels well qualified technically to handle this type of work.

You might be interested to know that the writer has been a constant reader of Gernsback Publications for the past twelve years and expects to continue reading them for they sure give you very valuable information that cannot be bought at any price.

EDWARD ARAND, Service Engineer,
Schwartz Radio Co.
1600 Race Street,
Cincinnati, Ohio.

A NEW BUSINESS FOR SERVICE MEN!

According to a recent Associated Press item, printed in a Tacoma, Wash. newspaper, a condenser which provides protection against electric waves has brought relief from years of suffering to Martin Bodker, known in this section as the human radio.

Bodker will wear a condenser designed by William G. Gunston, electrical engineer, and will no longer need to carry his wire-wrapped cane which has given him some relief.

"The trouble with Bodker," Gunston said yesterday, "is that his body offers far more resistance to electric and radio waves than the average body, with a resistance of about 40,000 ohms. Bodker's body offers so much resistance that it stores up electricity, and this is discharged at intervals with such rapidity that he is completely upset." (Three cheers for the "body discharger"! Let's get busy, Service Men, here is a wide-awake business for wide awake men—Hi!—Associate Editor).

IMPROVING OFFICIAL SERVICE MANUALS

Editor, RADIO-CRAFT:

Practically all radio sets have some particular part or gadget which will



Fig. 1

Three cheers for the "body discharger"!

eventually cause trouble. It is also quite evident that these same faults will occur in each similar model. Based on this contention, a scheme which I employ to make my set of the Official Radio Service Manuals indispensable and even more complete follows.—Whenever I encounter any "all-meat" items pertaining to radio service, be they self-experienced or obtained through reading in RADIO-CRAFT or elsewhere, these items are individually recorded on the O.R.S. Manual schematic diagram sheets in the following manner. Around the particular defaulting part or parts indicated in the item, is drawn a circle in bright red pencil; the use of "color" is represented in Fig. 2 by dotted lines. Then too perhaps if deemed necessary, notations of authoritative sources of reference

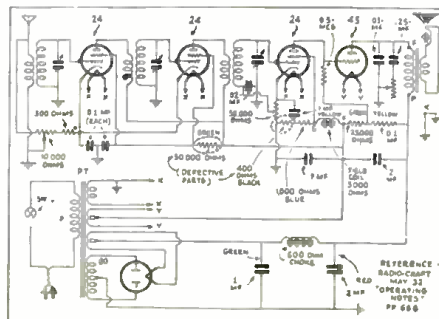

Fig. 2

A practical reference system.

are made along the border as illustrated in Fig. 2. Although this system may require a little "book-keeping," I find it is well worth the time and trouble of compilation.

JOHN J. LEEBL,
Spillville, Iowa.

FURTHER "INFO." ON "NOVEL EXPERIMENTS"

Editor, RADIO-CRAFT:

In reading the November, 1932 issue of RADIO-CRAFT I came across an article entitled, "Novel Experiments," in which Mr. Klase claims that by connecting a flashlight bulb or even a 40 W. electric bulb to the loudspeaker terminals of the radio set in place of the loudspeaker, he obtained good loudspeaker operation.

I would like to suggest to Mr. Klase that he should try the same experiment over again, and he will discover that the sounds do not come from the electric bulb, but are reproduced by loose laminations in the A.F. transformer.

WILLIAM TRAVNICEK
1119 West 17th St.
Chicago, Ill.

Editor, RADIO-CRAFT:

Referring to the letter from Mr. Wm. Travniczek, I am sending further data on "Novel Experiments."

The set first used in my experiments was a T.R.F. 6-tube set using a resistance coupled amplifier, battery operated. I found that reproduction of sounds was caused by shunting the lamp with my hand or hand capacity and by substituting a 1/4 to 1/2 meg. variable resistor it gave better results (a smaller value may be used).

Apparently it operates somewhat on the order of an electrostatic speaker. The 40 W. lamp should not be put in the socket too tight, but should be loose enough so that it has a little play at the base. A small neon tube will give good results due to ionization of the neon gas. Adjust the resistor to suit the lamp used. Then hold the lamp to your ear and hear the results. This experiment can be made on any set A.C. or battery.

Mr. Travniczek's suggestion is partly correct as I later discovered. One set used for experimental work was an Atwater Kent 44 A.C. It gave louder results than previous sets had and later proved to be due to loose laminations in the audio frequency transformers.

JOHN F. KLASE,
R. F. D. 1
Macungie, Pa.

THE NEWEST IN ALL-WAVE SUPERHETERODYNES

PART II

The new Masterpiece Model II receiver was designed as the result of analyzing a cross-section of comments and suggestions. The wavelength range is 13 to 570 meters. In this article Mr. McMurdo Silver concludes his discussion of the technical improvements incorporated in this real all-wave receiver.

McMURDO SILVER*

IN THE last issue of RADIO-CRAFT, appeared a general description of the new Masterpiece II all-wave superheterodyne. In this article are presented its circuit diagram and performance curves.

This receiver is the first all-wave broadcast receiver to employ a stage of T.R.F. amplification on both broadcast and short wavelengths; the first receiver of this type to employ air-dielectric tuning condensers in the I.F. amplifier; the first to employ 2A3 output tubes; the first to employ the new 2A7 S-G. first-detector and electron coupled oscillator

tube; and the first custom built all-wave receiver to employ band-spread tuning—a list of “firsts” quite enough to make it interesting.

Because of these and a number of other new features, plus the fact that every up-to-date engineering advance is found in it, the Masterpiece II permits the student to study in a single receiver practically the entire present day radio art in its most advanced form.

On the assumption that the November, 1933 issue of RADIO-CRAFT is handy for general reference, the circuit details will be explained without a preliminary review.

The Coils

Coils L1, L4, L7 and L10 are four different R.F. transformers with separate antenna primaries to permit the use of transposed or tuned two-wire lead-in systems. Separate primaries and secondaries are picked up by gang-switch sections Sw1 and Sw2 to couple the antenna to the 58 R.F. amplifier tube, S1.

Coils L2, L5, L8 and L11 are primaries and secondaries of the R.F. transformers coupling the T.R.F. amplifier to the first-detector, and are selected by gang-switch sections Sw3 and Sw4.

Coils L3, L6, L9 and L12 are oscill-
(Continued on page 362)

*President, McMurdo-Silver, Inc.

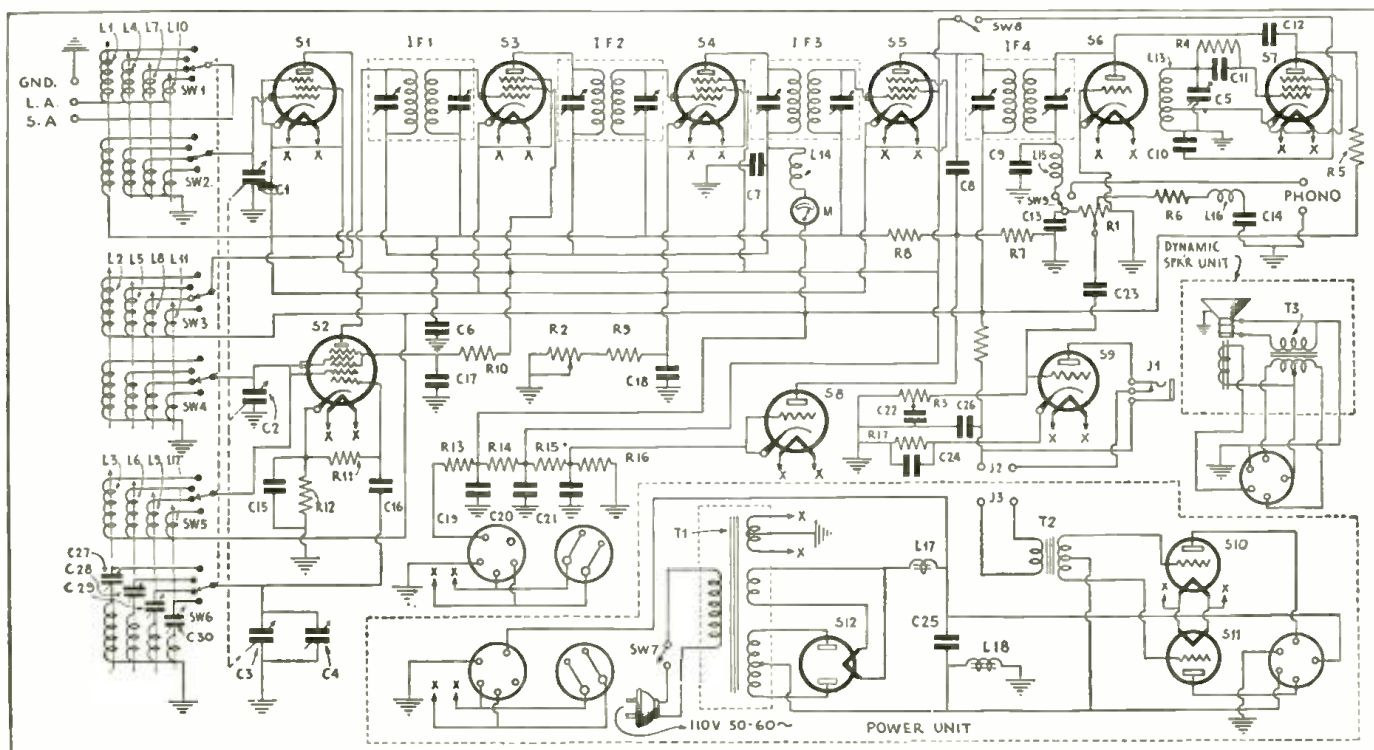

Fig. 1

Schematic circuit of the new McMurdo-Silver Masterpiece Model II all-wave superheterodyne. High-efficiency tubes are used.

SERVICING THE "TALKIES"

In the preceding issue of RADIO-CRAFT we announced this new series. In the present article the author starts right off with a detailed discussion of a representative sound talking motion picture installation—the "talkies" system at a Metropolitan theatre.

PART II

AARON NADELL

BEFORE any radio man can hope to succeed in obtaining theatre business he must have some fair idea of what talking picture equipment is like. A typical installation of this equipment is shown in the accompanying illustrations, Figs. A and B. It is proposed in this article to review—as completely as space allows—the more important characteristics of this and similar apparatus. In installments to follow, the problems this machinery imposes upon the projectionist and the manager will be described, after which the manner in which the radio man can fit himself into the picture should become plain.

Of course there will be no space here to go into such elementary electrical theory as Ohm's Law, or why an amplifier tube amplifies. It is assumed that the reader is familiar with such things. If he is not, this is not the place to learn them. The discussion to follow will take the ordinary electrical principles for granted, and confine itself to describing the manner in which those principles are applied in apparatus of this kind.

Ruggedness

What is most likely to strike the reader who looks at the accompanying illustrations is the ruggedness and mass of the

equipment, as compared with radio or the commoner types of P. A. amplifiers. It will be important for him to remember this strength of construction if he should, in the future, do any repair work on theatre equipment, and see to it that his repair is as sturdy as the apparatus to which it is applied; because that sturdiness is not an accident. It was explained in the introductory installment that "the show must go on" and that even a slight disturbance in the show is a business crime unpardonable. The apparatus is made strong accordingly. The same requirement will apply to repairs of any nature.

Figure A represents a double amplifier—one regular and one stand-by. Each amplifier is rated at 12 W. Each amplifier consists of three separate amplifiers in cascade, five stages of A.F. amplification altogether, the last two being push-pull. Power supplies are partially self-contained, but a storage battery (or a rectifier with a 12 V., 14 amp. filtered output in place of batteries) is also necessary to operate this installation. The rectifier is not shown in the picture.

It may save confusion to begin at the right of this picture, rather than at the left, and so eliminate some of the ap-

(Continued on page 378)



Fig. A
The "bank" of sound motion picture machines.



Fig. B
Just a few stages of A.F. amplification in panel style!

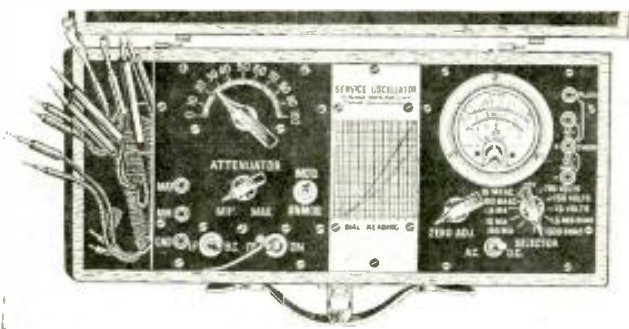

Fig. A
A combination signal generator and multimeter.

SERVICING by STAGE ANALYSIS

JOSEPH KAUFMAN*

The author, a writer who is known from coast to coast, describes for "new timers," a system of servicing which is known to experienced radio men. The advanced technician will learn a thing or two by reading Mr. Kaufman's description of a commercial test unit designed for isolation and test of individual stages.

MOST Service Men attach too much importance to getting instruments that will do things automatically. Why not adopt an approach—a technique—where testing equipment is of a fundamental character and is not subject to obsolescence? What I am about to present—*stage analysis*—is known to many experienced Service Men and practiced by them unconsciously!

A Basically Sound System

These men recognize that a radio receiver is like a chain with many links. A modulated radio signal is fed to the input and an audio signal is fed to the loudspeaker. Like the chain, any break or defect in only one link, stops the normal operation of the receiver. Their first impulse is to isolate the defective link (stage) at once. Not by using a set analyzer or a testing mechanism but by analyzing by means of their senses of *hearing, touch, smell and vision*, what the defect may be—they go from *effect to cause*.

I can't stress enough the idea of logical reasoning from *effect to cause*. An experienced Service Man may listen to a receiver and realize at once that a certain buzz is due to an off-center speaker, a certain squeal is due to an

* Director of Education, National Radio Institute.

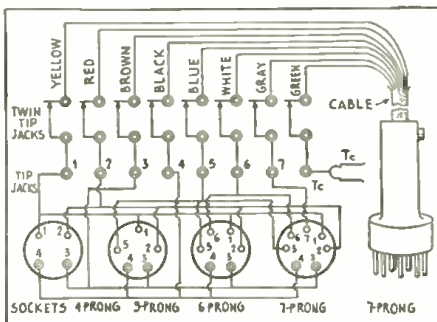

Fig. 2
Circuit of a "selective analyzer."

"Making Transformers and Chokes"

Due to the difficulty in preparing Part II of the article on the construction of audio and power transformers and chokes, Part I of which appeared in the preceding issue of RADIO-CRAFT, it was not possible to present Part II in the current issue. However, watch for continuations in subsequent issues.

open grid, an overheated output tube is due to a shorted "C" bias resistor. They will tune a receiver and quickly realize that the tubes are dead. When a receiver is noisy, they quickly ascertain by the process of elimination whether the noise is produced internally or externally. (All this is an essential part of their technique and precedes any instrument method of trouble-shooting.)

A few more pointers conclude the suggestions for a visual check-up. A receiver may fail to work because a tube is burned out; the aerial and ground system incorrectly installed or connected to the receiver; a tube not firmly in place; a top cap not in position; or a part on top of the chassis visibly defective. Examine the chassis, tubes,

power supply and pickup system and eliminate surface defects at once. Check the main power supply. Only then should the Service Man resort to the use of instruments.

(Continued on page 365)

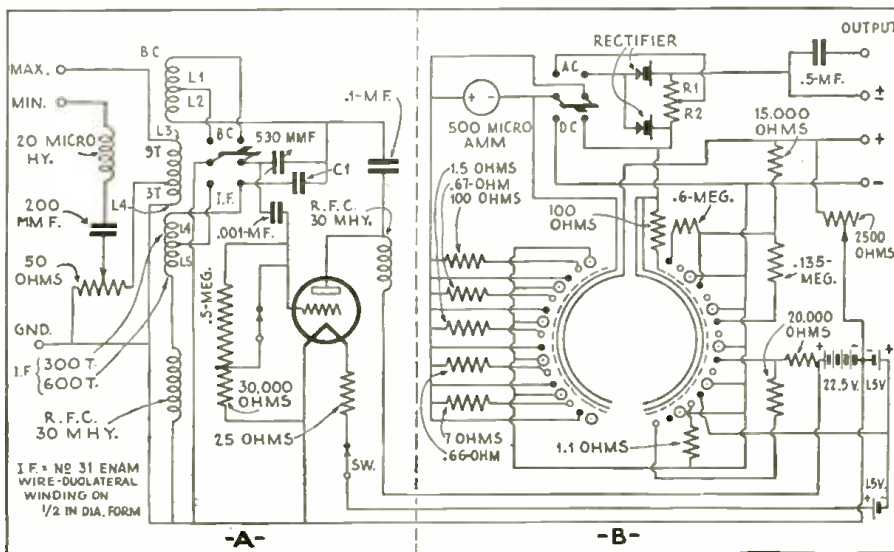

Fig. 1
In A, the service oscillator connections; the multimeter diagram is shown at B.

How To Make A Compact, Powerful 6 V., D. C. AND 110 V., A. C. 1-UNIT P. A. SYSTEM

LOUIS GANCHER*

A new standard of compactness in P.A. apparatus for operation on either 6V., D.C., or 110 V., A.C., is established in this design of a single-case system. The assembly includes a 10 W. amplifier, dual-service phono. motor and dynamic reproducer, and related units.

PURCHASERS of P.A. amplifier equipment are divided into two groups . . . those who rent out such systems, and those who purchase them for their own use. The amplifier system described here was designed to meet every possible requirement of both the groups.

To those who rent out P.A. Systems this design will prove of special appeal, for, it enables such men to conveniently transport the equipment from one rental to another, and by virtue of its universal powered construction, the same amplifier can be employed anywhere.

(This method of universal operation was completely described in articles appearing in the September, October and November issues of *RADIO-CRAFT*, entitled, "Constructing a Complete 26-Watt Dual-Channel P.A. System."—*Assoc. Editor*.)

The Amplifier

The input circuit of the amplifier shown in Fig. 1A, consists of a ½-meg. stabilizing resistor R1, connected across the input posts, BP1 grid, BP2 ground,

requiring an external input control system. The output of this first tube, V1, a type 56, (serving as a pre-amplifier!) is resistance coupled into the second A.F. stage, utilizing another 56 tube. This is, in turn, resistance coupled into an 89 "driver" 3rd A.F. stage, the output of which is transformer coupled, T1, into a conventional class B type 53 tube as the 4th A.F. Stage. Both plates of the 53 power output tube are connected to a class B output transformer, T2, having the following voice coil and line secondaries: 500, 200, 15, 8, 4 and 2 ohms, any three of which may be brought out to the voice coil outlets (FS 1, FS 2 and FS 3 shown in Fig. A) fastened on the side of the portable case, such as the 500 ohm, the 15 ohm and the 8 ohm outputs.

The two 56 tube filaments are connected in parallel, and then in series with the filament of the 53 tube and a ½-ohm, 5 watt resistor. The remaining 89 tube is connected directly across the 6 V. filament supply—see Fig. 1B. This novel arrangement keeps the filament current drain comparatively low, and make possible the use of tubes with

(Continued on page 371)

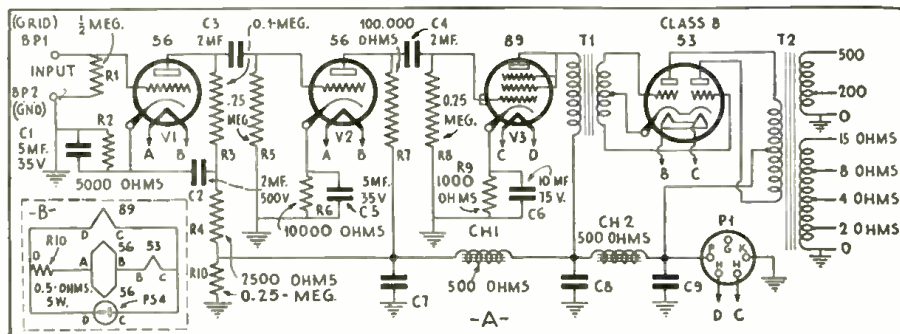

Fig. 1

The circuit of the amplifier (A) and details of the filament circuit (B).

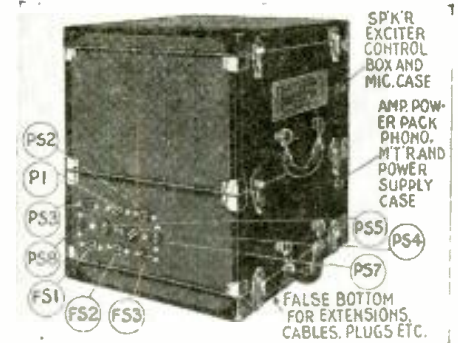

Fig. A

The P.A. system in inter-locking cases.

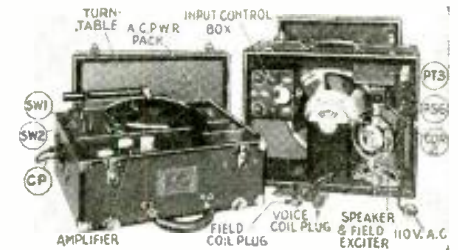

Fig. B

The P.A. and phono. unit ready to operate.

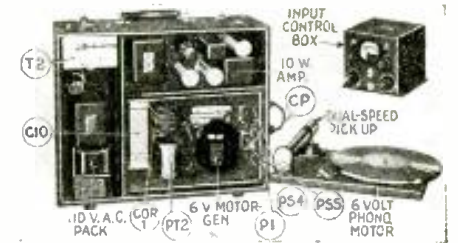

Fig. C

The components of the system.

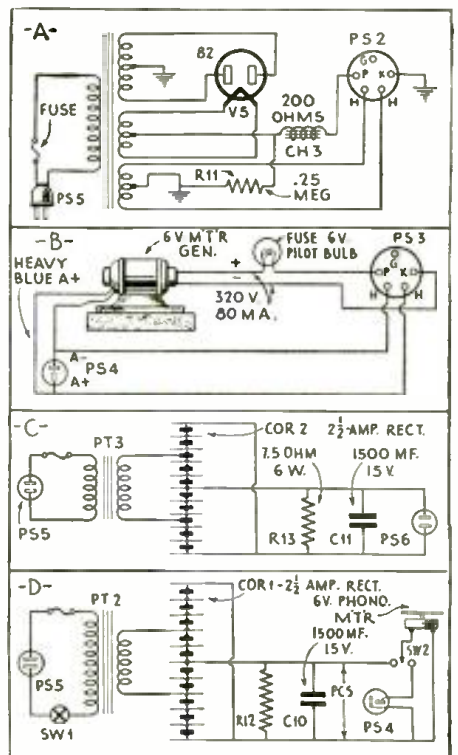

Fig. 2

The circuits of component units.

HOW TO INSTALL A REMOTE CONTROL ON 1-DIAL SETS

At last, we have a practical, reasonably priced remote control unit. It does everything possible with higher priced units and is destined to be a "best seller."

HUBERT L. SHORTT*

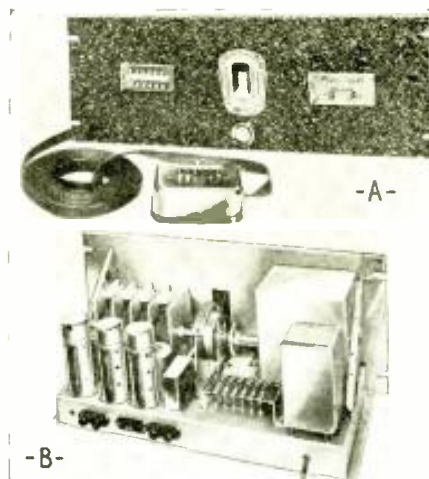

Fig. A
Front and rear view of remote controlled set.

THE Service Man, or P.A. engineer is not in the business for his health;—like every other business, this enterprise must show a profit. To make it do so, he is obliged to take advantage of the trends in radio, giving the public what it desires and demands.

Many business men fail to appreciate the fact that it is extremely expensive to try to create public demand by the process of education. On the other hand, where such a demand exists, it is very profitable to cater to it.

In radio, we have had many object lessons to illustrate this point. During the past few years, there has been a constant trend toward simplification and compactness in radio receivers. When the midget first appeared, wide-awake radio men reaped a rich harvest from them. Recently, history repeated itself, with the introduction of the unique portable A.C.-D.C. sets. Because these convenient little receivers followed the trend of demand, their sales appeal has been enormous.

And now, once more, we find another radio development which promises great popularity and hence opportunities for profit. The American public has placed a definite stamp of approval on radio "remote control" as a refinement offering greatly increased convenience. Some of the most important radio receiver manufacturers, such as Philco, Stromberg-Carlson, RCA-Victor, etc., have recognized this fact and have announced new models equipped with remote control arrangements. There are, however, hundreds of thousands of older model sets, excellent in every other respect, but not fitted with remote control. Owners of the latter sets will want to have them modernized, and the fulfillment of this desire will serve as an unlimited source of profit to progressive Service Men who know Opportunity when it knocks.

* Wholesale Radio Service Co., Inc.

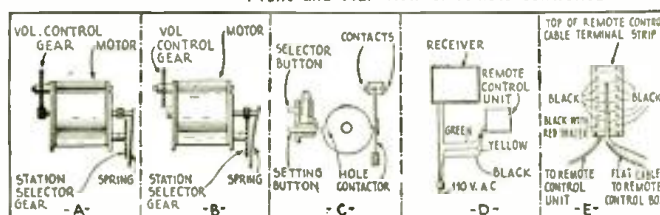

Fig. 1
Mechanical details of the selector and wiring of the cable

To be salable, the remote control must be well made, reliable, positive acting, noiseless and easy to install. Furthermore, it is essential that its price meets the limitations imposed by present economic conditions. Otherwise it will remain unpurchased, no matter how much it is desired.

The remote control illustrated in Fig. A and described in this article meets these specifications in every particular. It is highly efficient, can be installed readily on almost any radio receiver and can be purchased complete at such a low price that the Service Man can give his customers a superfine remote-control job, charging the very reasonable sum of \$25.00 and still make a respectable profit.

How It Is Done

The conception of controlling and operating a radio set at a distance is by no means new. However, the first attempts to construct such devices were crude and costly. The electrical and mechanical difficulties were gradually ironed out, resulting in the modern control unit described here. This device is shown in the accompanying illustration, Fig. A, in this instance being hooked up to a 7 tube superheterodyne receiver. Any other single-dial receiver could be used with the remote control in exactly the same way. With this unit,

(Continued on page 375)

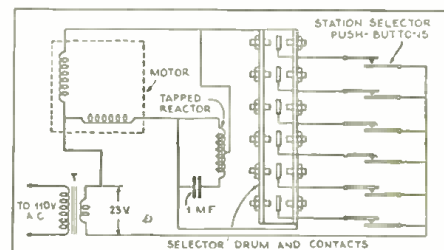
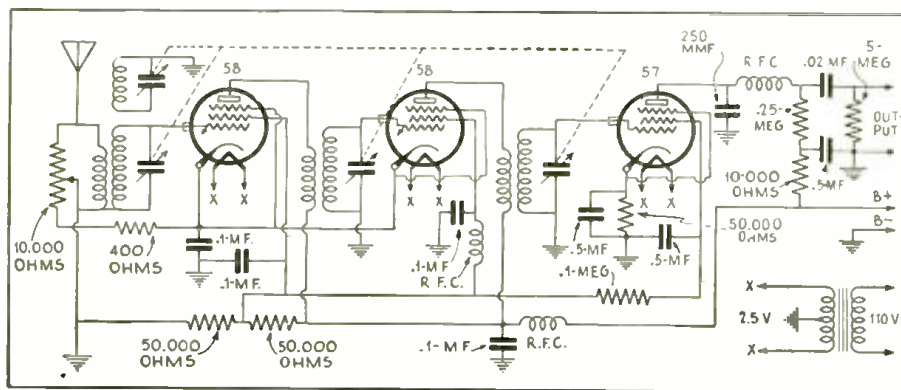

Fig. 2, above; Fig. 3, left

Schematic circuits of the remote control and the T.R.F. tuner units. The A.F. circuit following the tuner may be of conventional type.

THE ANALYSIS OF RADIO RECEIVER SYMPTOMS

OPERATING NOTES

IVER PAULSEN

KOLSTER REPAIRS

A Kolster K-70 receiver would occasionally cut off to a whisper if the tone control was turned to another position. Everything seemed to test O.K. but attention was focused on the pentode circuit because of somewhat similar trouble in another popular make. Finally the 0.1-mf. coupling condenser between the plate of the second detector and the grid of the pentode shown in Fig. 1 was found leaky, but only after it was tested with high voltage—further proof of the need of adequate voltage for testing condensers.

HUM IN APEX MODEL 8

An Apex Model 8 set developed terrific hum as soon as the switch was snapped on. This hum was traced to the 8 mf. cardboard electrolytic filter condensers, which tested open. (See Fig. 2.) It seemed queer that both of them should test open, so they were opened up, and in each case one of the connecting straps was found entirely corroded away.

DISTORTION IN PHILCO SETS

A Philco model 20 ran perfect for a few minutes after being turned on, and then signals became "mushy." The cause was finally traced to the 0.5-meg. gridleak in the 27 tube circuit, shown in Fig. 3. This resistor had a value fluctuating between 0 to 500,000 ohms, which caused the delay in locating the trouble.

Another time this set developed severe "static" and sputtering, and with the analyzer plugged in, the voltages varied with the different intensities of crashes, and then suddenly dropped to zero. The trouble was found to be caused by the filter choke becoming grounded, due to the insulation breaking down and allowing the wire to touch the core.

MORE ABOUT "AUDIOLA JR."

Here are several faults in the "Audiola Jr." chassis, in addition to the resistor trouble, mentioned in the May 1933 issue of RADIO-CRAFT. The ones I have come across bore the name "Westminster" and were dressed up in big cabinets. One showed up with no plate voltages, which was traced to shorting of the .01-mf. condenser from the plate of the type 45 tube to ground. (Later found on others.) Another developed a bad case of "oscillationitis" all over the dial, which no amount of aligning or tube changing would cure. The trouble was finally located in the R.F. bypass condenser. This is a dual 0.1-mf. metal case condenser, and the only ground connection of this condenser is the rivet which also holds down one side of the second R.F. socket. This rivet had worked loose, making a very poor ground

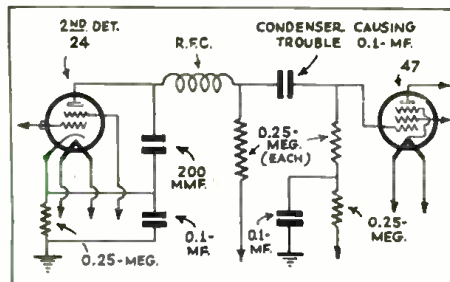

Fig. 1
Fixing a Kolster K-70.

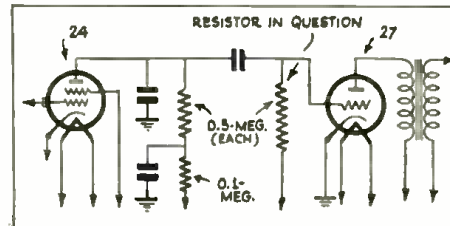

Fig. 3
Trouble in a Philco 20.

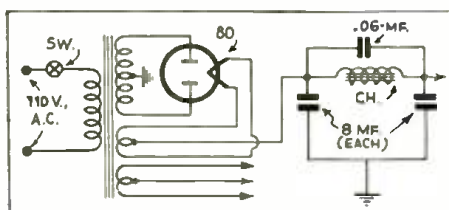

Fig. 2
Condenser connections caused trouble.

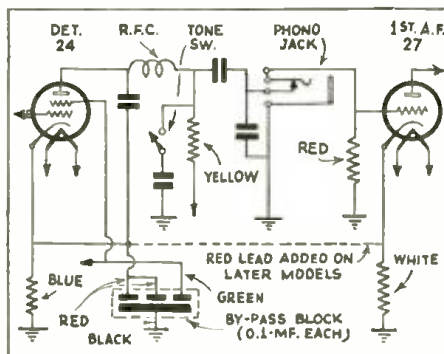

Fig. 5
The "red" condenser sections broke down.

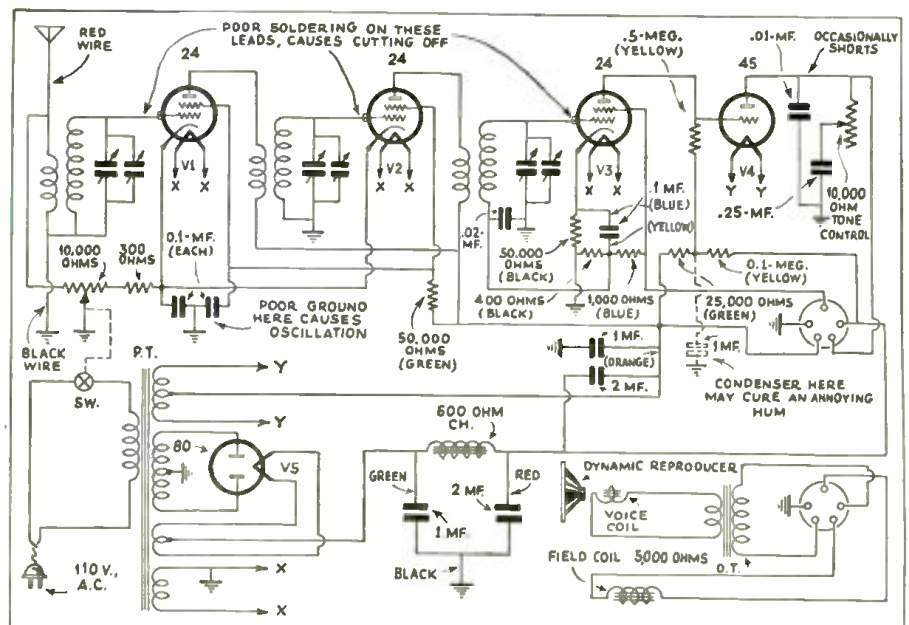

Fig. 4
The Audiola Junior. Several faults and their correction are described.

MAJESTIC MODELS 440, 500, AND 800 SUPERHETERODYNE RECEIVERS

(Model 440 chassis is used in receiver models 44, 49, and 194; the chassis incorporates the new type 6F7-S and 6Z5 tubes; 2-band reception. The model 500 chassis is used in receiver models 55 and 59; the circuit incorporates type 6A7-S, 6B7-S, and 6F7-S tubes; 2-band reception. The model 800 chassis is used in receiver models 85 and 86; features 8 tubes, police-call reception, A.V.C., and class B A.F.)

MODEL 440 CHASSIS

The output of this set is approximately 2.5 W. The frequency range in one position of the wave-change switch is 535 - 1,530 kc.; in the other, 1,470 - 3,500 kc. Field coil resistance is 980 ohms. Clockwise rotation of the wave-change switch at the back of the chassis adjusts the circuit for short-wave reception.

| Tube Type | Cath. Volts | S.-G. Volts | Plate Volts |
|-----------|-------------|-------------|-------------|
| V1 | 3.5-10 | 92 & 0 | 225 & 92 |
| V2 | 12 | 92 & 0 | 255 & 100* |
| V3 | 13 | 255 | 240 |
| V4 | 315 | 0 | 285 |

*Measured with 0.6-meg. ohmmeter. The line potential is 115 V., 60 cy. The filament potential of all tubes is 6.3. (The filaments of V1 are connected in parallel.) To align, set wave-change switch in broadcast position, adjust R1 for maximum volume, and turn the condenser gang to full mesh. Now, supply a 456 kc. signal to the converter grid of V1 and align I.F. trimmers "C" for maximum sensitivity. Finally, supply a 1,500 kc. signal to the input of the receiver, tune it in, and then align the oscillator and R.F. circuits of V1 for maximum sensitivity.

Reverse the line plug position for least noisy operation, as determined by the effectiveness of C11.

A feature of this receiver is the exceptionally high gain obtained through the use of new tubes and careful circuit design. Tube V1 is a combination oscillator and

first-detector; V2 is a combination I.F. amplifier and second-detector; V3 is the usual output tube.

MODEL 500 CHASSIS

The broadcast frequency-range of this chassis is 535-1,530 kc.; the short-wave range is 1,480-4,140 kc. Note the following: (A) wide band coverage; (B) short-wave sensitivity is equivalent to the broadcast band; (C) broadcast signals are not heard during short-wave reception.

Tube V1 is a combination oscillator and first-detector. Tube V2 is a combination I.F. and A.F. amplifier. Tube V3 is a combination I.F. amplifier, second-detector and A.V.C. tube.

| Tube Type | Cath. Volts | S.-G. Volts | Plate Volts |
|-----------|-------------|-------------|--------------|
| V1 | 2.8 | 100 & 0 | 210 & 90 |
| V2 | 2.8 | 100 & 0 | 250 & 60 |
| V3 | 12.0 | 100 & 0 | 250 & 0 |
| V4 | 17.0 | 250 & 0 | 235 |
| V5 | — | — | 340 (A.V.C.) |

Voltagcs to ground; line, 115 V.

The I.F. output of the pentode section of V3 is fed separately to its diode plates; one set is used for the channel and the other for A.V.C. The use of separate diodes for these two purposes results in exceptional fidelity, since the A.F. diode is not negatively biased; and results in extremely good

A.V.C., since full A.V.C. may be exercised on V1, V2, and V3. The reproducer is of plug-in type; the field coil has a resistance of 980 ohms. The gang condenser has a 5 to 1 ratio planetary drive; the dial is calibrated in kc. for both wave bands; switch S is located at the rear of the chassis.

MODEL 800 CHASSIS

This receiver provides an exceptionally good tone control circuit, police-call reception, A.V.C., and class B output from a single tube; the type 4-8 tube is used in two positions.

Tube V1 is an R.F. amplifier; V2, oscillator and first-detector; V3, I.F. amplifier; V4, A.V.C.; V5, second-detector; V6, A.F. driver; V7, push-push class B, A.F. amplifier; V8 is the usual full-wave rectifier.

| Tube Type | Cath. Volts | C.-G. Volts | S.-G. Volts | Plate Volts |
|-----------|-------------|-------------|-------------|-------------|
| V1 | 0 | — | 103 | 103 |
| V2 | 0 | —3 & 0 | 103 & — | 250 & 103 |
| V3 | 0 | — | 103 | 250 |
| V4 | 0 | — | ... | 0 |
| V5 | 12.5 | ... | ... | 0 |
| V6 | 12.5 | 0 | ... | 245 |
| V7 | — | — | ... | 245 |
| V8 | ... | ... | ... | 315 |

The tuning range of this receiver is 535 to 1,730 kc. and includes the police-call band.

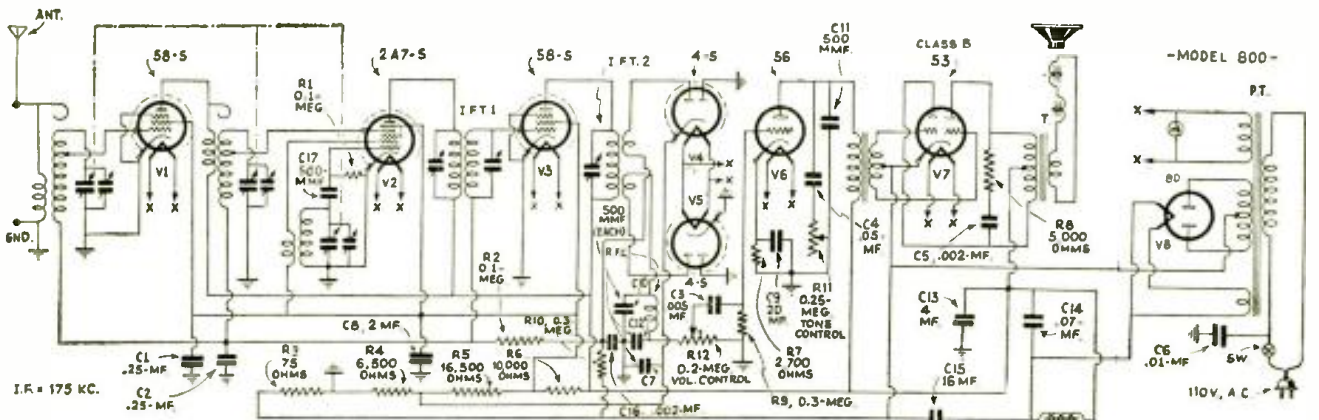
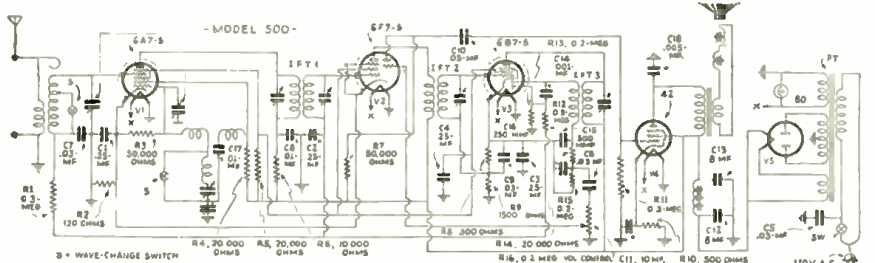
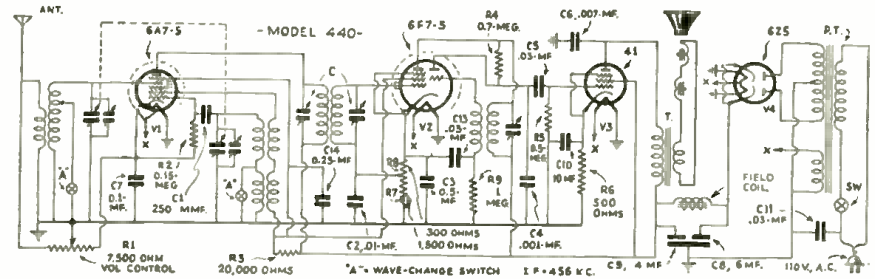
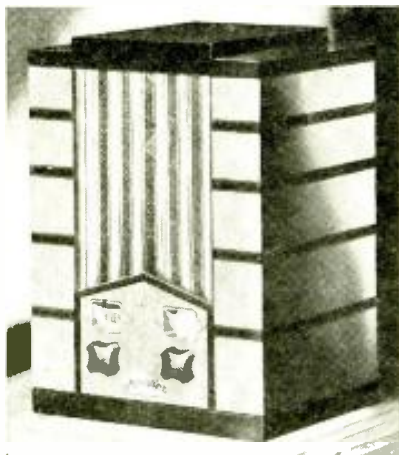

STROMBERG-CARLSON No. 33 6-TUBE AUTOMOTIVE RADIO RECEIVER

(Incorporates the new, high-efficiency tubes; A.V.C.; tubeless "B" supply; tone control; kc. dial calibration; load-delay "B" relay; interstage noise suppression.)

In the No. 33 receiver the type 78 tube, V1, is used as an R.F. amplifier and its output is coupled to the type 6A7 tube, V2, which is a composite first-detector and oscillator. The I.F. generated in the output of this type 6A7 tube is fed to the pentode portion of the type 6B7 tube, V3, which functions as an I.F. amplifier. The two diode sections of V3 are operated on the amplified I.F. signal. One diode is used for A.V.C. and controls the types 78 and 6A7 tubes, V1 and V2, respectively. The other diode is used for A.F. detection and its load resistor is coupled to the volume control potentiometer R13 through R12 and C17.

The arm of the volume control feeds the A.F. signal to the control-grid of V4, the A.F. amplifier, and so-on in the usual manner.

The type P-23466 Elkonode vibrator unit may be checked by substituting the unit to be tested, in a receiver kept set up for this purpose. If the unit under test performs correctly in this set, but does not operate in a satisfactory manner in the receiver being tested, the trouble will be found elsewhere in the circuit. If the check shows that the unit does not operate correctly, it should be replaced with a new one. Do not attempt to service Elkonode units.

When the on-off switch is turned "on," the battery voltage is applied to the heaters of the tubes in the receiver unit, the dial lamp, and the power relay in the combination speaker and power unit. The contacts of the power relay are, therefore, closed and the battery voltage is applied to the vibrator power supply. A slight hum will be heard from the vibrator. In a few seconds when the tubes have heated, the load-delay relay armature will pull up, cutting off the temporary load resistor R18. This resistor is kept in circuit, until the tubes reach operating temperature, to control the voltage applied to the receiver. Both of these relays must perform correctly if the receiver is to function correctly.

Voltage readings are obtained by measuring between the various tube socket contacts and chassis base, with the tubes in place. Detail A in the diagram shows the terminal layout of the sockets with the correct terminal numbers. The terminals of each socket are numbered, starting with one heater pin as 1 and proceeding clockwise around the pin circle to the other heater pin. This is done looking at the bottom of the socket.

Voltages are read on the meter scale (1,000 ohms per volt) normally used for the magnitude of the particular voltage except as otherwise specified. The voltages given are those obtained when the battery voltage is 6.3 V.

| Tube | Grid | Terminal | Socket | Terminal | Socket | Terminal | Socket |
|------|------|----------|--------|----------|--------|----------|--------|
| Type | Clip | 1 | 2 | 3 | 4 | 5 | 6 |
| V1 | 0 | -6.1 | +187 | +81 | +2.9 | 2.9 | 0 |
| V2 | 0 | -6.1 | +187 | +81 | +187 | -2 | -3.6 |
| V3 | 8.1 | -6.1 | +187 | +81 | +3 | 100 | 12 |
| V4 | - | 0 | +166 | 0 | 11 | -6.1 | - |
| V5 | - | 0 | +184 | +187 | 0 | +14.5 | -6.1 |

Note: These readings are made with the positive pole of the storage battery grounded. If the negative is grounded, the heater voltages will naturally be reversed. These voltages will vary slightly from the averages given due to tolerances in resistors, variations in tubes, battery voltage differences, etc.

The figures given at the top of the table, above, are identified with the socket terminals as follows: Tube V1, cap. control-grid; 1, "hot" heater; 2, plate; 3, screen-grid; 4, suppressor-grid; 5, cathode; 6, grounded heater. Tube V2, cap. detector control-grid; 1, "hot" heater; 2, plate of detector; 3, screen-grid; 4, plate of osc.; 5, control-grid of osc.; 6, cathode; 7, grounded heater. Tube V3, cap. control-grid; 1, "hot" heater; 2, plate; 3, screen-grid; 4, A.F. diode; 5, A.V.C. diode; 6, cathode; 7, grounded heater. Tube V4, 1, grounded heater; 2, plate; 3, control-grid; 4, cathode; 5, "hot" heater. Type V5, 1, grounded heater; 2, plate; 3, screen-grid; 4, control-grid; 5, cathode; 6, "hot" heater.

Continuity and resistance tests may be made with all tubes removed from their sockets and the power cord removed from the receiver unit. The on-off switch should be turned "off." The readings then obtained, in ohms, should conform with the set of representative figures given below, in connection with detail B in the diagram.

Measurements are made between the points indicated by the two figures, as follows:

| Points | Ohms | Points | Ohms |
|---------|--------|--------|--------|
| 3/1 | open | 12/1 | 0 |
| 6/1 | open | 15/7 | 0 |
| 7/5 | 0 | 14/3 | 20 |
| 8/3 | 70 | 15/3 | 20,000 |
| 9/3 | 20,000 | 16/3 | 1 |
| 10-11/1 | 450 | 17/18 | 50,000 |

| | | | |
|-----------|----------|-------|-------------|
| 18/1 | 500 | 33/30 | open |
| 19/1 | 0 | 34/3 | 0 |
| 20/5 | 0 | 35/1 | 2,700-3,700 |
| 21/3 | 45 | 36/1 | 450 |
| 24/1 | 20,000 | 37/5 | 0 |
| 25/1 | 0.2-meg. | 38/1 | 0 |
| | 1 meg. | 39/4 | 0 |
| | 2,600 | 40/3 | 0 |
| 26/1 | 0 | 41/1 | 2,700-3,700 |
| 27/1 | 0 | 42/1 | 450 |
| 28/3 | 5,500 | 43/5 | 0 |
| 29/1 | 0-10 | 44/1 | 2,000 |
| Sw. "off" | | 45/1 | 1.1 meg. |
| 30/1 | 3,000 | 46/1 | 1.1 meg. |
| 31/5 | 0 | 47/1 | 25 |
| 32/1 | 0 | 47/46 | open |
| 33/2 | 0 | | |

Do not re-align the receiver unless it is absolutely necessary. The procedure is as follows:

Connect the leads of a service oscillator adjusted to 260 kc. between the control-grid cap of V2 and the chassis base. (A fixed condenser of 0.5-mf. should be connected in series with the lead going to the control-grid to insulate the 260 kc. service oscillator from the voltages of V2.)

Connect the output meter across terminal M of the fuse block and the combination speaker and power supply frame. This puts the meter across the moving coil of the speaker (4 ohms impedance). The signal should be very weak, just sufficient to show a deflection on the output meter.

Now adjust C10 and C11 for peak swing on the output meter. (It will be necessary to check over these adjustments as they are somewhat interdependent.) Now, similarly adjust C18.

To align the R.F. and oscillator circuits, connect the service oscillator to the antenna input terminal through a 200 mmf. condenser, with the "low" side of the service oscillator connected to the chassis base.

Next, tune the service oscillator to 1,400 kc. and set the dial of the remote control unit at 140. Make sure that the signal applied is only strong enough to give a deflection on the output meter. Adjust the oscillator trimming condenser for maximum deflection of the meter; then, similarly adjust the R.F. and antenna trimmers.

Finally, tune the service oscillator to 600 kc. and adjust padding condenser C7 for maximum meter deflection. (If this adjustment is very far out it is advisable to re-set to 1,400 kc. and check the setting of the oscillator trimming condenser.)

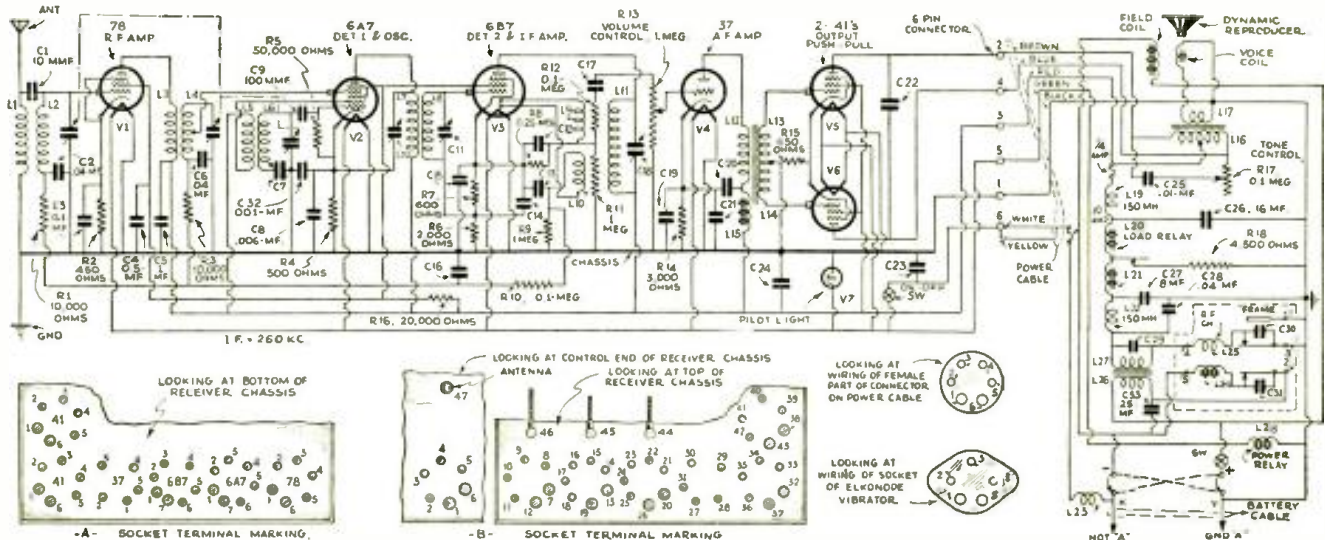

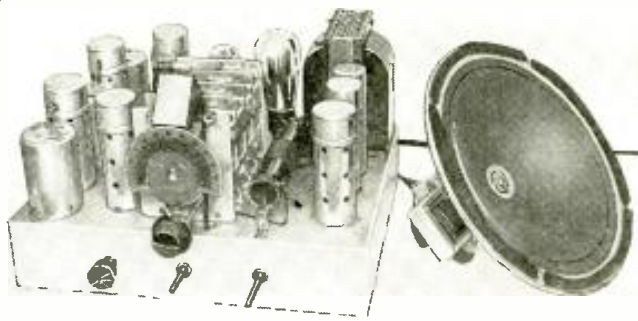

Fig. A
Front view of the modernized "Ultra-Modern Super."

BUILDING THE NEW 1934 ULTRA- MODERN SUPER

CLIFFORD E. DENTON

SO MANY requests for more information about this popular receiver have been received in the last year that something had to be done to satisfy the readers of RADIO-CRAFT.

Letters from set constructors all over the country report reception from coast to coast and from Mexico City to the smaller stations in Canada at real consistent loudspeaker volume; less than ten kc. selectivity (if desired) and over 78 clear channels without any trouble.

If the builder desires to sacrifice selectivity for quality, then the I.F. transformers can be detuned slightly. Actually, it is necessary to detune the I.F. transformers considerably before the actual selectivity of the receiver is impaired to any great extent.

In building the 1934 model, one thought was kept in mind. All of the parts used in the construction of the 1933 model must be used and the additional equipment necessary must be obtainable anywhere. *It is not necessary to discard any of the original parts specified*, with one exception. Due to the changes in the base connections to the newer type tubes the pentode sockets must be changed from 5 prong to 6 prong and the first-detector socket must be changed to one of 7 prong small-type,

instead of the 6 prong used in the first instance.

The main changes lie in the wiring of the various parts so that smoother operation and even greater sensitivity can be obtained.

The Circuit

It is interesting to compare the original diagram which was printed in the October 1933, issue of RADIO-CRAFT, page 202, with Fig. 1. The following details deserve particular mention as they constitute the high-lights of the new design.

(a)—Improved A.V.C. Circuit. The A.V.C. action has been changed over to the two I.F. tubes only, thus resulting in greater stability and still providing excellent control.

(b)—New 2A7 Tube Combines Oscillator and First-Detector. This new development in vacuum tubes results in higher efficiency in converting the broadcast signal to the intermediate frequency of 175 kc. and does away with the separate oscillator tube. Socket connections and characteristics of this new tube will be found in Fig. 2.

(c)—Tuning Meter. So many requests came from builders of this set for in-

(Continued on page 363)

FEATURES:

- (a) Improved A.V.C.
- (b) Type 2A7 first-detector and oscillator.
- (c) Visual tuning meter.
- (d) Type 2A6 second-detector.
- (e) Silent tuning switch.
- (f) Band selector.

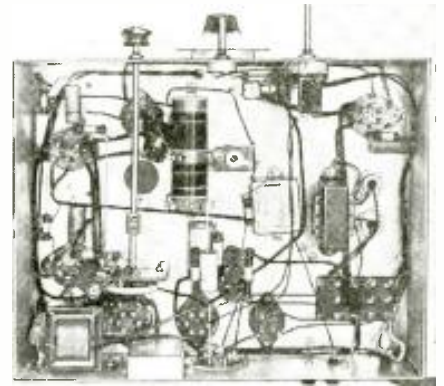

Fig. B
Underside view of the "new" set.

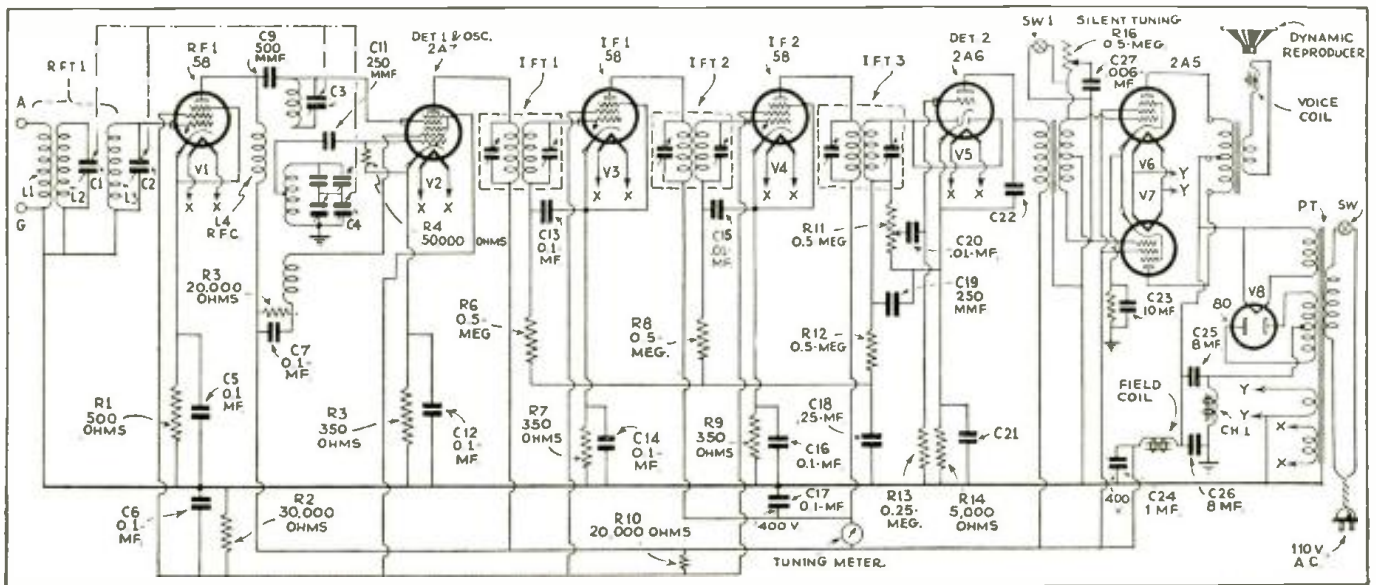

Fig. 1

Schematic circuit of the "1934 Ultra-Modern Super." Compare with Fig. 1, page 202, of the October, 1932 issue.

Now



..YOU CAN HAVE A RECEIVER EXACTLY LIKE ADMIRAL BYRD'S

BRIEF SPECIFICATIONS

Wave length Range 10 to 570 meters or 520 to 30,000 kc. Four position wave change switch.

(External unit extends range from 700 to 2000 meters.)

Tuned R. F. stage on both Broadcast and entire Short Wave range yet single dial tunes the receiver. Greatly improves signal-noise ratio on 12,000 mile reception.

Band-spread tuning on short waves. Makes short wave tuning actually easier than broadcast tuning.

3 air-tuned intermediate stages. Most accurate intermediate amplification ever developed.

Sensitivity better than 1/4 micro-volt absolute average.

Interstation noise suppressor adjustable to exact location requirement.

Automatic volume control holds all stations 20 microvolts and up at constant volume to the ear.

Selectivity absolute 9 Kc. for Europe, better than U. S. needs (21 Kc. wide 10,000 times down).

Fidelity perfect over 30 to 4,000 cycle audio range.

Undistorted power output, 15 watts.

Automatic and manual tone controls.

Special impregnation for tropical climates.

Built-in beat oscillator for easy finding of S. W. and weak broadcast stations.

Chromium plated steel shielding case eliminates need for cabinet.

10 day trial in your home. Open-and-shut guarantee. Money back instantly if you are not absolutely satisfied—no questions asked.

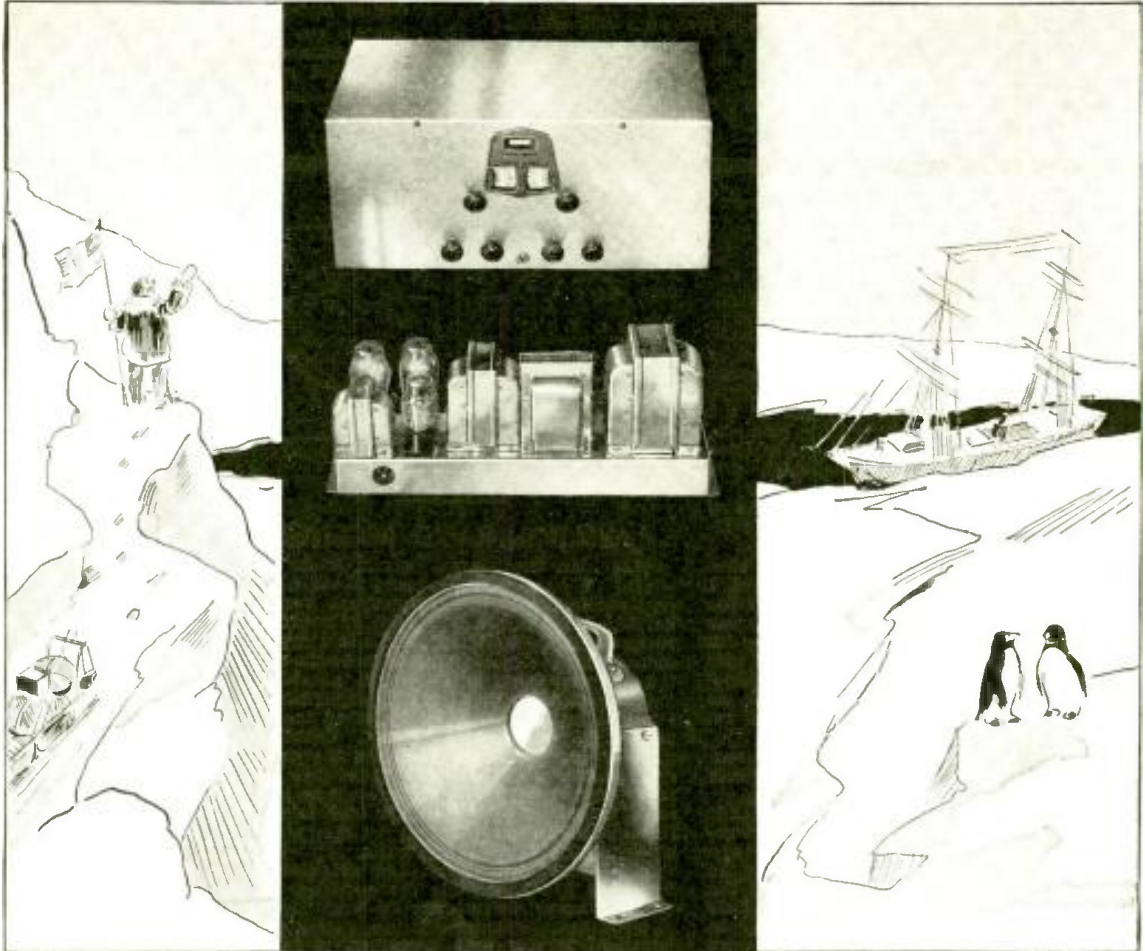

MASTERPIECE II's . Especially designed to serve as broadcast and communication receivers on the Byrd Antarctic Expedition

For the first time in the history of a radio, a broadcast receiver is considered sufficiently able to fulfill the functions of communication receiver as well.

MASTERPIECE II, product of McMurdo Silver's laboratory, is relied upon for communication and broadcast service, by the Byrd Expedition during his two year stay in the Antarctic.

But . . . let us not deceive ourselves. This receiver is not "just a good radio," selected for an important task simply because it appeared to be better than others available. Indeed not! MASTERPIECE II was designed especially for the work to be done—five of them serve as the official communication receivers of the expedition.

The engineering of Masterpiece II provides a degree of dependability in transoceanic reception that eliminates all possibility of failure. It's just good enough to stake lives on—the lives of the whole Byrd Expedition!

Its construction incorporates ample provision for equally certain performance in tropic heat and antarctic cold. Mechanically, MASTERPIECE II will withstand most anything.

A great eastern university . . . the greatest in the field of radio research and engineering, having collaborated in furnishing the specifications for Admiral Byrd's receiver, considers MASTERPIECE II a major advancement in the art of radio reception. And now YOU can have one . . . a radio exactly like Admiral Byrd's!

10 Day Trial—Money Back Guarantee

So that you can see for yourself . . . by actual test . . . that MASTERPIECE II is the finest receiver for 10-570 meter world wide reception, I will gladly send it on 10 day trial. If for any reason you decide not to keep it, simply return the receiver and I'll make complete refund instantly—no questions asked. The coupon from this page will bring full details of MASTERPIECE II.

McMurdo Silver, Inc., 1735 Belmont Ave., Chicago, U.S.A.
Send me full information on Masterpiece II.

Name.....

Street.....

Town..... State.....

McMURDO SILVER, Inc.

1735 BELMONT AVENUE - CHICAGO, U. S. A.

RADIO-CRAFT'S INFORMATION BUREAU

SPECIAL NOTICE TO CORRESPONDENTS: Ask as many questions as you like, but please observe these rules:

Furnish sufficient information, and draw a careful diagram when needed, to explain your meaning; use only one side of the paper. List each question. Be SURE to sign your name AND address.

Those questions which are found to represent the greatest general interest will be published here, to the extent that space permits. At least five weeks must elapse between the receipt of a question

and the appearance of its answer here.

Replies, magazines, etc., cannot be sent C. O. D.

Inquiries can be answered by mail only when accompanied by 25 cents (stamps) for each separate question; answers are subject to subsequent publication, if considered of exceptional interest.

Other inquiries must be marked "For Publication."

MICRO-MIDGET ANALYZER (Correction)

(224) Mr. Ed. C. Mould, Pittsburgh, Penna.
(Q.) I would like to call your attention to the Micro-Midget Analyzer on page 662 of the May, 1933, issue of RADIO-CRAFT. I think if you will check over this circuit and the chart showing the position of the selector switch, you will note a slight error in one of the socket connections V2. Take, for instance, the 45 tube, which shows G2 for the selector switch and according to the circuits, this would be G3.

(A.) We are printing material furnished by Mr. Serotta in answer to Mr. Mould's inquiry.

I wish to acquaint you with the fact that when I sent my article in to be published, I described two methods of construction for the special switch S1. When the article was published, however, only one method was included. The method described does not conform with the switch shown in the photograph and this confused many readers, as indicated by some of the letters I have received.

The incorrect and correct methods of connecting the socket V2 are shown in diagram Q224, A and B. The changes are obvious.

Several readers have complained that they have trouble with the 4, 5, and 6 prong composition sockets shorting when a tube was inserted. This can be remedied by taking the sockets apart and trimming the ends of the contacts a little to prevent them from touching. Also, a small amount of solder may be flowed behind each contact to form a more positive connection to the tube prongs.

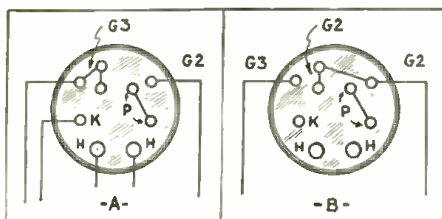

Fig. Q-224
A "Micro-Midget" correction.

AVIATION RADIO RECEIVER

(22) Mr. Roy Mantz, Detroit, Mich.

(Q.) I have recently heard about a new crystal-controlled superheterodyne receiver developed by the Bell Telephone Laboratories, for use in the reception of signals in airplanes, during flight. As the frequency bands allotted to portable transmission in planes are much narrower than those permitted for broadcasting, the receivers employed for this service must tune very sharply. Could you possibly obtain some information for me regarding this new receiver? I am sure that many readers of RADIO-CRAFT would be interested in knowing just how the high selectivity is obtained, especially in the compact design required for aviation units.

(A.) Because of the limited width of the frequency band available for aviation, telephone communication and the large number of operating companies desiring frequency allocations, it has been necessary to assign channels with a frequency separation of only

about one-tenth per cent. Since this separation is only one or two-tenths of the separation of broadcast channels, the difficulty in selecting the desired channel without interference from adjacent ones is evident.

In the development of the Western Electric 12A receiver, this selectivity problem has been fully and satisfactorily met. And in spite of this, the receiver weighs no more than previous aviation receivers with a much lower degree of selectivity.

A schematic diagram of the receiver is shown in Fig. Q-225. To obtain the required degree of selectivity and sensitivity, a superheterodyne circuit is employed. From left to right in the diagram, there is one stage of T.R.F. amplification, a first detector, three stages of I.F. amplification at 385 kc., a second detector and A.V.C. tube, and one stage of A.F. amplification, a separate tuned circuit for each frequency is employed for the R.F. stage and for the oscillator.

Operation of a shifting mechanism selects the proper circuits for the frequency desired, the circuits having been properly tuned while the plane was on the ground.

In any radio receiver the usable sensitivity is limited by the tube and circuit noise. When this limit has been reached, sensitivity to still weaker signals is obtainable only by increasing the voltage input. For a given field strength, the voltage induced in a given antenna is fixed, but the voltage across a tuned circuit in series with the antenna can be much greater. Antennas ordinarily used for airplanes have a comparatively low resistance, and so lend themselves to the series tuning which is employed in this receiver with excellent results.

(Continued on page 361)

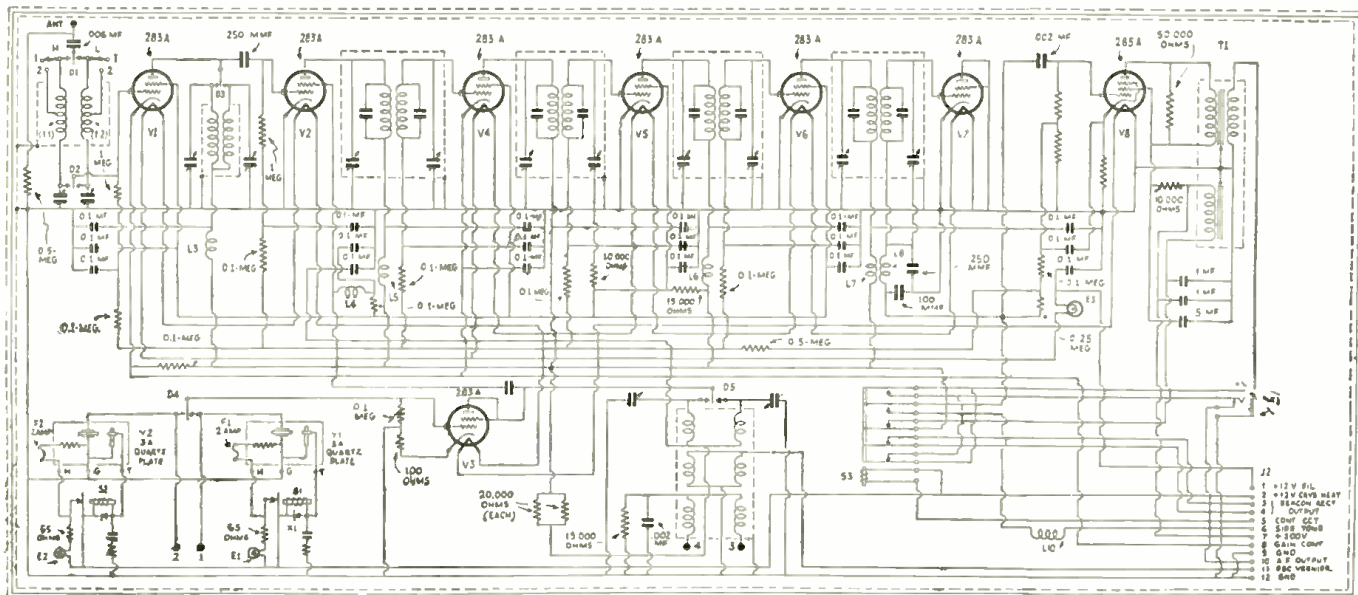

Fig. Q-225
Schematic circuit of the new W.E., ultra-selective crystal-controlled superheterodyne receiver developed for aircraft use.

THE RADIO MONTH IN REVIEW

(Continued from page 330)

Chicago. Senatore, now the Marchese (Marquis) Guglielmo Marconi and the Marchesa Marconi arrived at New York on the Italian liner *Conte di Savoia* on September 28th.

Piloted by David Sarnoff, head of the Radio Corporation of America, to the new Radio City, just opened, Marconi had to run the gauntlet of some twenty-odd radio scribes who corralled him in one of the rooms in Radio City and lambasted him with radio questions, mostly foolish.

Marconi graciously let it be known that he came to the United States "to learn something about wireless."

Sarnoff disputed this point of the illustrious one-eyed inventor by stating that "no one in the United States can teach Marconi anything about wireless."

After having divested himself in good humor of the radio reporters, Marconi was taken to the roof of Radio City, where he was duly photographed—returning to the Ritz-Carlton Hotel later, where he spent the night. He then embarked for Chicago, where he arrived on October 2nd.

Here, a great tribute was paid to Marconi, as the father of radio, at a luncheon given in his honor at the Museum of Science and Industry. From this he rose, at Mr. Roosevelt's invitation, to greet the President, with whom he was photographed. Subsequently, returning to his own luncheon, he said: "The money aspect of the development of radio must not be forgotten. For example, my first experiment in broadcasting across the Atlantic cost more than \$200,00."

In concluding the ceremonies, Rufus Dawes, president of the exposition, presented a special medal to Senatore Marconi at the Century of Progress; while a light-beam from the star Capella, picked up by a telescope in Florence, Italy, and sent by radio and telegraph to Chicago, switched on the floodlights of the Fair. The inventor then flashed around the world, by wireless, the letter "S," which thirty years ago he sent so dramatically across the Atlantic.

SILENT BEDLAM

A TREMENDOUS crash is heard, the grinding of metal upon metal, splintering of glass, the screams of the heroine; then, the siren of the traffic cops, the roar of hundreds of actual voices of the dear populace. Shots are fired at the hit-and-run driver responsible for the crash.

These are the noises that issue forth from your loudspeaker, as you sit in your study and listen to the latest radio presentation. Vaguely, you picture in your mind's eye a large room in which all these noises are manufactured, with

RADIO TOURS

LET'S GO PLACES AND HEAR THINGS!

Replace weak, limping tubes with tubes made by RCA—and come on along!

DON'T be a stay-at-home...limited to the few stations near at hand! Come on a Radio Tour! Get the thrill of a "first night" in Hollywood...the Hill Billy "Shindig" in Asheville...those German comedians in Milwaukee...the "Tent Show" in Des Moines...your own college football game back home... "The Kingfish" speaking in Louisiana... Rhumba players down in Havana. A million dollars worth of radio entertainment is waiting for you... Go places, hear things! With new, powerful tubes, with a good radio set thoroughly in order you can bring in stations beyond the reach of tubes that are worn and old.



Step into the heart of Chicago, hear the famous programs from the loop—on a Radio Tour!

Have your dealer test your tubes

To go on a great radio tour every night—your ticket is simply a good radio set plus a new set of Cunningham Radio Tubes or RCA Radiotrons to replace weak and limping tubes. Only RCA Radiotrons and Cunningham Radio Tubes are actually *made and guaranteed* by RCA. Built to give you full, complete tone, wide range, sure performance and long life.

A remarkable free booklet, "Radio Tours" tells you whether your set is giving you all it should. It lists all stations in the U. S., Canada, Mexico; it provides a "radio yardstick" and a map that shows your own locality and all the stations you *should* get. Ask your nearest dealer for "Radio Tours"—or mail coupon below.



A million dollars worth of radio talent—yours on a radio Tour!



Broadway and the great White Way. The heart of the show business... go there on a Radio Tour!



San Francisco's Chinatown...all the entertainment of the Golden West—on a Radio Tour!



Cunningham Radiotron

Without any obligation please send me your illustrated folder "Radio Tours" with station map and "radio yardstick." I am enclosing 10c in stamps for postage and handling.

Name

Address

(Coupon must be sent to RCA Radiotron Co., Camden, N.J.)

14





“What-a-Man”

Holder of ALL records—takes the cup for superior performance on Every Test.

No wonder they out-perform and out-wear so-called “just-as-good” fixed resistors. Service men take note:

Specify Centralab.

Centralab

CENTRAL RADIO LABORATORIES

MILWAUKEE

WISCONSIN

Give SERVICE

... with a Small Inventory

Here is the best Volume Control Proposition on the Market. Here are the reasons why?

1. Over 400 “exact duplicate” controls in the “X” series.
2. Yet with SIX controls in the original-AD-A-SWITCH-SERIES 477 sets can be serviced.
3. By combining controls in both lines any requirement can be met with minimum stock investment.
4. Clarostat with its two separate lines offers the widest range of controls to choose from.
5. Clarostat Controls are inseparable from Quality Service Work.

(Clarostat “X” line has over 400 controls to choose from—start as to electrical overall resistance, taper, bushing, shaft length, and will fit into exact space in set.)

(Clarostat Ad-A-Switch line comprises the maximum utility with minimum stock investment. Series W (Wire Wound) obtainable from 50 to 50,000 ohms. Series C (new composition element) obtainable from 10,000 to 5,000,000 ohms. Both lines obtainable in all tapers—insulated shaft 1 1/2” long. Wire use is indicated as follows: W-28 will service 128 sets; C-28 will service 108 sets; W-29, 77 sets; C-59, 66 sets; etc., etc.)



NEW CONTROL REPLACEMENT GUIDE ON REQUEST

CLAROSTAT MFG. CO., INC.

287 North 6th Street, Brooklyn, N. Y.
AD-A-SWITCH was originated by Clarostat.

hundreds of people being employed to bring it all about.

You are due for a disappointment; because, the next time, if you have a friend at one of the key stations of a large broadcasting net, you may step into the studio where all the noise originates, and you will find that here “bedlam reigns” silently. Everything is very prosaic, and at the most there are only three or four people in the studio, speaking in moderately low voices. Where, then, is all the noise coming from?

If you look closer, you will see a long table with about ten phonograph turntables; one operator sits in front of them. The turntables are all rotating. The operator merely depresses a push-button, which brings the phonograph pickup down on a precise spot of a certain phonograph record when the cue is given. This one phonograph record may give the exact reproduction of the automobile crash. Depressing the next button, the pickup descends upon the spot which unloosens pistol shots. The next will give a marvelous reproduction of a roaring crowd. Meanwhile, the operator who pushes the buttons does nothing but wear a pair of phones and listen to the output of the phonograph discs. You see, all the pieces have been recorded from actual crashes, actual crowds, actual shots, etc. When required, an impresario simply orders whatever “noises” he wants; this is much simpler, much less costly, and the noises can be used at any time later on. This new scheme has been developed into perfection by the Camden, N. J., plant of the Radio Corporation of America, and is now in use.

The ease with which the sound effects can be injected into the program by this method is just one more example of the remarkable development of broadcasting in the past few years.



The new Broadcast Noise Robot creates anything from the roar of 10,000 baseball fans to the crash of two automobiles.

RADIO BY DUN & BRADSTREET

WHEN Dun & Bradstreet—now joined together—say something about any industry, you listen respectfully; and now it appears that we have actually turned the corner, even in radio, and that the big, bad wolf, “Depression,” is now really a thing of the past. So listen carefully, and see what Dun & Bradstreet have to say officially about your industry:

“Orders are being received in such volume that manufacturers now are behind in their deliveries, despite increased operating schedules, and retailers are pressing for shipments as their old stocks have been cleared and consumer demand is forging ahead from week to week.”

“The future of the radio industry seems brighter than it has been in several years, as prices have increased, stocks have been cleaned of antiquated models, budgets have been adjusted, and many evil trade practices have been eliminated.”

“Since June, there has been an unusually strong upturn in the demand for radios in most parts of the country,” the survey continues, “the poorest showing being made by the South and some sections of the Northwest. With many manufacturers of popular-priced sets, orders are now running ahead of production, with retailers placing fresh commitments, as soon as the delivery of former ones has been made. With the increase in the prices of sets and the shift of demand to the better-grade units, value of output has increased from 50 to 85 per cent, in comparison with the record for the nine months of 1932, while unit volume is higher by 15 to 45%.”

“While the strongest demand continues decidedly in favor of units priced at \$15 to \$50, during the last sixty days more interest has been displayed in the small console sets falling within the price range of \$30 to \$70. Short-wave sets are increasing in popularity, as listeners are interested in tuning in our foreign programs.”

As far as bankruptcies are concerned, things are looking up too. Conditions are getting so good these days that, while we had three and one-half million dollars of bankruptcies in 1930, we have only a paltry \$2,641,250 in 1933. The following table by Dun & Bradstreet makes this more evident.

| MANUFACTURERS | | |
|---------------|--------|----------------|
| Year | Number | Liabilities |
| 1930 | 40 | \$3,522,400.00 |
| 1931 | 15 | 4,088,445.00 |
| 1932 | 23 | 1,826,995.00 |
| 1933* | 17 | 2,641,250.00 |

| WHOLESALE AND RETAILERS | | |
|-------------------------|--------|----------------|
| Year | Number | Liabilities |
| 1930 | 217 | \$2,071,392.00 |
| 1931 | 160 | 4,979,359.00 |
| 1932 | 170 | 1,978,678.00 |
| 1933* | 80 | 1,475,266.00 |

* January to August, inclusive.

RADIO TYPEWRITERS

ONCE upon a time, you used to send out-of-town messages by the dot-and-dash method, as practiced by Western Union. Last year, the great and powerful American Telephone & Telegraph Company perfected their "Teletype" machines, which they rent to you. Owing the wire system themselves, they rent you the Teletype machine, which is nothing but a typewriter, to which a telegraphic transmitter has been attached, and a similar machine is placed in your Chicago office for the paltry sum of \$1.20 for 3 minutes and 40¢ for each additional minute. A New York merchant can now send all the messages he wants to his Chicago office, day after day. He couldn't afford to do that by sending straight messages by Western Union or Postal Telegraph.

Not to be outdone in this line of endeavor, and to make the operation still cheaper, a number of radio enthusiasts have been working on the radio typewriter for years.

Clyde Fitch, well known to readers of RADIO-CRAFT, and inventor of the Tropadyne radio circuit, has been active in the development of radio typewriters; and last month Radio Industries started manufacturing them in a Binghamton, N. Y. plant.

The chief outlet at the present time is the U. S. Army and Navy. It is expected that large factories, brokers, etc., will use the radio typewriter presently.

Mr. Fitch recently demonstrated it in New York, where it was operated between uptown and downtown offices on 5 meters, and worked to a charm. It seems to be foolproof with the exception of one old bugaboo—and that is static. Old Man Static, when he gets going, is liable to print some letters that were not intended originally; but, unless the static is exceedingly bad, it doesn't make much difference, because you can easily spot the incorrect letters. Anyhow, even ordinary wire telegrams contain misspellings traceable not to static but to clerical mistakes.



The new Radio Typewriter now ready for the market. News and static are equally enjoyed by it.

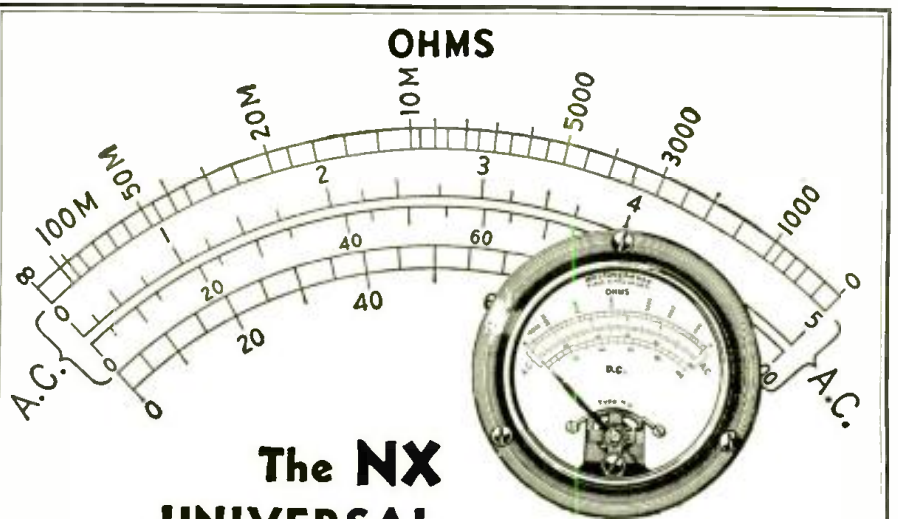

The NX UNIVERSAL RECTOX INSTRUMENT

Ideal for use in Test Sets . . .

HERE is an instrument that measures practically every electrical quantity needed in the diagnosis of receiving set ills.

The instrument, self-contained, has these ranges:

- 0-1 milliamperes, d-c. (resistance 100 ohms)
- 0-1 milliamperes, a-c. (resistance 5000 ohms)
- 0-100 millivolts, d-c. (resistance 100 ohms)
- 0-5 v., a-c. (resistance 5000 ohms)

The following additional ranges can be obtained by the use of accessories which are furnished separately:

- 0-1-5-10-50-100-200-500-1000 volts, d-c.

- 0-10-50-100-200-500-1000 volts, a-c.

- 0-1000-10,000-100,000 ohms
- 0-5-10-50-100-500 milliamperes, d-c.

- 0-5-10-50-100 milliamperes, a-c.
- 0-1-5-10-50 amperes, d-c.

The instrument, mounted in a case, with all the necessary switches, resistances, and shunts to give the desired ranges, makes an ideal test set.

A new catalog, 43-341, just completed, describes and lists the new NX Universal Rectox Instrument and all resistors and shunts, and includes connection diagrams. Send the coupon or a post card for your copy.

Westinghouse

Quality workmanship guarantees every Westinghouse product



SEND FOR CATALOG

Westinghouse Electric & Manufacturing Co.
Dept. 111, Room 2-N—East Pittsburgh, Pa.
Gentlemen: Please send me a copy of Catalog 43-341.

Name
Address T 79717
City State RC 12-33

Be sure to turn to page 374 of this issue and read about the new 1933 OFFICIAL AUTO-RADIO SERVICE MANUAL which is now published.

TRUMAN RADIOS

are

CUSTOM BUILT

Broadcast, Shortwave and Auto Radios

Write for dealers prices

TRUMAN RADIO SHOP
7443 Stewart Ave., Chicago, Ill.

WANTED!

Jobbers—Mail Order Houses and Representatives
in all Territories

TWO FAST MOVERS



Free Edge Cone and Voice Coil Assemblies
And—Field Coils for all Dynamic Speakers
We also Manufacture Various Types of Magnetic Speakers
We can Supply and Remedy Your Speaker Needs.
Speaker Mfrs. Since 1921
LEOTONE RADIO CO., 63 Dey St., New York, N.Y.

Get Your Copies of the SHURE TECHNICAL BULLETIN

Because of the widespread interest in the SHURE TECHNICAL BULLETIN and the numerous requests for back issues . . . the following back issues are available now at

6c per copy.

- No. 1** Condenser vs. Two-Button Microphones.
- No. 2** Field Problems in Microphone Placement. Part 1—Broadcasting.
- No. 3** Field Problems in Microphone Placement. Part 2—Public Address Systems.
- No. 4** Mixing Circuit Design Data.
- No. 5** The Microphone—An Electric Ear. Noise Measurements—Binaural Transmission.

The SHURE TECHNICAL BULLETIN . . . a monthly publication of the Shure Brothers Company, 215 W. Huron St., Chicago, microphone makers . . . contains **AUTHORITATIVE AND USEFUL INFORMATION** on microphones, microphone placement, design data on associated speech-input circuits, new applications of microphones for industrial and research purposes, and similar technical phases of broadcast and sound engineering.

Copies of the SHURE TECHNICAL BULLETIN may be had without charge by broadcasting, public-address and recording engineers simply by sending in your request on your company's letterhead.

Subscriptions accepted from amateurs, radio service men, and others at the nominal fee of 50c per year.

To be sure of having these valuable issues send for them now. Use the coupon below.

SHURE BROTHERS COMPANY
215 W. Huron Street, Chicago, Ill.

Please send me postpaid the following back issues of the SHURE TECHNICAL BULLETIN:

* _____ No. 1 _____ No. 3

_____ No. 2 _____ No. 4

I am enclosing _____ No. 5
_____ c (in stamps) (in cash).

Please enter my subscription for one year. I am enclosing 50c in stamps in cash in money order.

Name _____

Address _____

City and State _____

RC12

SUPER P.A. SYSTEM

(Continued from page 338)

were employed, and the latter units were separated to give "perspective" to the music. Individual microphones were used for each of the amplifier systems for picking up the voices of the chorus and singers. These artists performed in a sound proof room and were not seen by the audience; the results of their efforts depended entirely upon the sound system.

In addition to the voices projected over the auditorium, organ music and a carillon were used. Since these instruments were located at some distance from the Armory, specially balanced telephone lines (balanced to 16,000 cycles) were used to carry the organ and bell music. To avoid distortion in the pickup from the carillon, a microphone located in a sound tunnel at the base of the bell tower was used.

The Reproducers

To cover the entire audible frequency spectrum, three banks of speakers, with a total of 20 speaker units were used! These were classed as follows:

(a) For reproduction of the low frequencies from 16 to 200 cycles, two speakers (one for each amplifier system), each weighing 300 lbs. and having cones 20 in. in diameter, were mounted at the top of the "temple," some 60 or 70 feet above the floor of the auditorium. One of these speakers is shown in Fig. B. The size of the cone and voice coil used in the speaker can be clearly seen from the photograph, Fig. C, by comparing the size of the hand and pencil pointing to it.

(b) For reproduction of the middle-register frequencies from 150 to 5,000 cycles, 10 speaker units were employed. Five of these units were used for the middle "register" of each of the two amplifier systems. These speakers were mounted between the bass-note units, as shown in Fig. D.

(c) For reproduction of the high frequencies from 1,800 cycles to the limit of audibility, (Approximately 20,000 cycles!) 8 units were employed. Some of these high-register units were of the magnetic type, while others contained crystal units. Two of these speakers are shown in Fig. E.

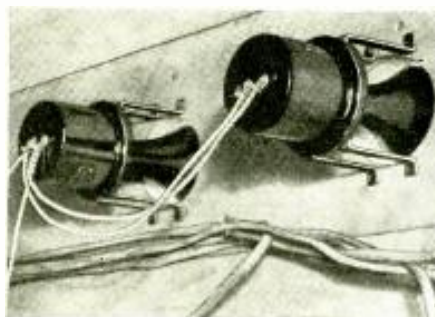

Fig. E

Two of the high-frequency speakers in use.

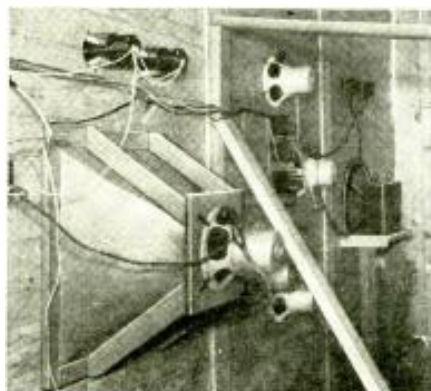

Fig. F

Back of baffle; one-half of the speakers.

One-half of the speaker installation, showing the temporary wiring, may be seen in Fig. F. This shows the back of the baffle board, which, on the front, was painted to represent the "temple" shown in Figs. A and B, from which all of the sounds were projected.

The Amplifier Systems

To give an idea of the connections from microphone system to the bank of reproducer units, a block layout has been drawn. This is shown in Fig. J, and represents one-half of the complete installation. The sounds were picked up in the microphone; amplified in the single stage pre-amplifier; mixed with other sound effects in the mixer units; amplified in the two stage pre-amplifier; attenuated or accentuated in the master gain control; amplified in the main voltage amplifier; distributed to three separate power amplifiers for the low, middle, and high registers, respectively, and projected through the speaker units previously described.

(Courtesy is extended to Mr. T. F. Bludworth, President, and Mr. W. C. Blaisell, Chief Engineer, Bludworth, Inc., who gave the writer every possible assistance in the preparation of this article.—Author)

This article will be completed in a subsequent issue of RADIO-CRAFT.

INTERNATIONAL RADIO REVIEW

(Continued from page 339)

extent in quartz, tourmaline and sodium chloride crystals.

Electrical double refraction is a secondary effect in which the light is influenced indirectly by the electrical field, through a dielectric. The static field directs the molecules of the crystal, according to the field strength, increasing or decreasing the angle of rotation in the polarized plane, proportionately. It was found that such an effect was confined to cubic crystals which could, in turn, be divided into two groups; the regular rock-salt type and the eccentric group, in which the final solution of the problem was found, namely the zinc sulphide crystal.

For experimental purposes a small plate of crystal was cut and filed. The dimensions were about 3 x 5 x 1/2-in. thick. The crystal plate was then mounted between two brass springs and the potential applied via these contacts. See Fig. 2 A and B; also Fig. B. The crystal assembly was then placed between two crossed Nicol prisms, and mounted in the television receiver, using a Nipkow scanning disc. The results filed, within practical limits, all the requirements of the ideal light modulator. These modulators are being sold commercially in Europe.

A NOVEL A.V.C. SCHEME

A RECENT issue of Wireless World, London, England, contained an explanation of a system for obtaining the plate and grid potentials for an A.V.C. unit from the voltage drop in the speaker field coil, by connecting this coil in the negative lead to the "B" circuit.

This is a plan that might often be adopted when installing A.V.C. in an existing receiver of the superheterodyne type; it is not suitable for "straight" sets for the reason that a sufficiently high signal voltage is not available on the plate of the detector for signals on the high-frequency end of the scale.

The essentials of the control system are shown in Fig. 3. By using this system the correct voltages will be applied to the A.V.C. tube; the plate will be positive with respect to the cathode and the grid will be negative by an amount depending on the position of the slider on the 0.1-meg. potentiometer. This slider is provided so that the working voltage of the A.V.C. grid may be set at a value which gives the correct amount of delayed action. This position is easily found by tuning in a weak signal and then moving the slider gradually from positive to negative until a point is reached where the signal begins to decrease in volume.

The actual voltage across the speaker field coil is unimportant; 60 volts will give results, but a higher voltage is desirable.

INFORMATION BUREAU

(Continued from page 356)

Quartz plates are employed for controlling the frequency of the beating oscillator, thus insuring the correct frequency for satisfactory operation under all conditions and without attention on the part of the operator. Two oscillators are provided, and the one required is selected by the operation of the same control that selects the proper tuned circuits.

Under some operating conditions the high degree of frequency stability and freedom from attention on the part of the operator provided by the quartz plates may not be required. The 12A receiver has therefore been designed so that in such cases a tuning unit may be used in place of the quartz plates. These are plug-in tuned circuits whose constants are much more stable than are those of ordinary tuned circuits. The coil is wound on an Isolnrite form, and the adjustable condenser has a thermostatic metal plate to reduce variations due to temperature changes. The units are mounted in moisture proof aluminum cans to avoid changes in the oscillator frequency caused by changes in humidity.

Automatic gain control, widely used with present-day broadcast receivers, is even more important with airplane receivers, since in addition to the usual fading due to variation in the transmission path, there is a large change in signal strength due to the travel of the plane. With the system employed in the 12A receiver there is a barely noticeable change in audio output with a variation in signal input of 10,000 to 1. Even with this wide range in automatic control, however, a certain amount of manual control is desirable. An input in excess of half a volt is too great to be properly handled by the automatic control, and since voltages of this magnitude may be applied when the plane is flying close to the transmitter, a manual control is provided near the operator's position, where it may be adjusted as required. Under normal conditions no adjustment is necessary during flight. A variable level control, also, is provided to allow the operator to adjust the headset volume to a comfortable value.

The power required for the heaters of the vacuum tubes is 3.2 amperes at 12 volts. A ballast lamp in the heater supply circuit provides adequate regulation for applied voltages from 11.5 to 14.5 volts. When the quartz plates are employed for frequency control, an additional intermittent drain of 2.4 amperes is required at the same voltage. For the plates and screens some 40 milliamperes is required at 200 volts, which is furnished by the small dynamotor operated from the battery.

An input of one microvolt at the antenna gives an output of over twelve milliwatts, which is more than sufficient for headphone reception. Such high sensitivity is not required for normal operation, but it insures a sufficient reserve of amplification to give satisfactory reception under abnormal conditions. The outstanding performance of this receiver, together with its simplicity of operation, should be of considerable value in increasing the reliability of aviation communication.

This information regarding the W. E. 12A receiver was furnished by the Bell Telephone Laboratories, Inc.

DON'T FORGET — —

to look for the article in the next issue describing the construction and uses of the radio "growler." While the principles involved are well known, the uses are novel and extremely useful. No Service Man or experimenter should be without one. And even more interesting is the fact that all the parts can be retrieved from the junk-box.

NATIONAL UNION RADIO TUBES CHOSEN BY SERVICE EXPERTS



Thousands Acclaim Free Offers— Quality

Far more than the free shop equipment, set analyzers, tube testers, service manuals, technical data and service merchandising aids is responsible for the nationwide acclaim given National Union tubes by leading service experts.

National Union tubes are more profitable because they are 10c. higher in list price, engineered and made to the highest standards of laboratory precision. Service men know that when they install National Union tubes they are establishing customer good will by giving more than money's worth.

If you haven't taken advantage of the free meters, manuals and data given with National Union tube purchases—get details at once.

National Union is the service man's tube line—best by all tests. Thousands are prof-

iting—why not you? Send coupon now—equipment offers subject to withdrawal without notice!

SERVICE EXPERTS SAY

Note: These are excerpts from unsolicited letters received by National Union.

"... find your tube the very best on the market. ... have tested National Union tubes which have been in use for three years and found them perfect"

"... I am full fledge National Union tube dealer and proud of it."

"... pleased with the idea of higher list price and your sales methods."

"... found National Union tubes have stood up with all tests and requirements as advertised."

EXTRA! Ask about profit possibilities in Led-erer Ultra Violet Lamp installations. New. A money maker.

National Union Radio Corporation of N. Y.
400 Madison Ave., New York, N. Y.

Gentlemen: Tell me how I can take advantage of your equipment offers.

NAME

STREET

CITYSTATERC12

STANDARDS of SERVICE

There is no logical reason for using test equipment below proved Weston standards—since the long, dependable service which these thoroughly engineered test units give makes them cost far less in the end. Bulletin RA tells the whole story. Send for a copy... Weston Electrical Instrument Corp., Newark, N. J.

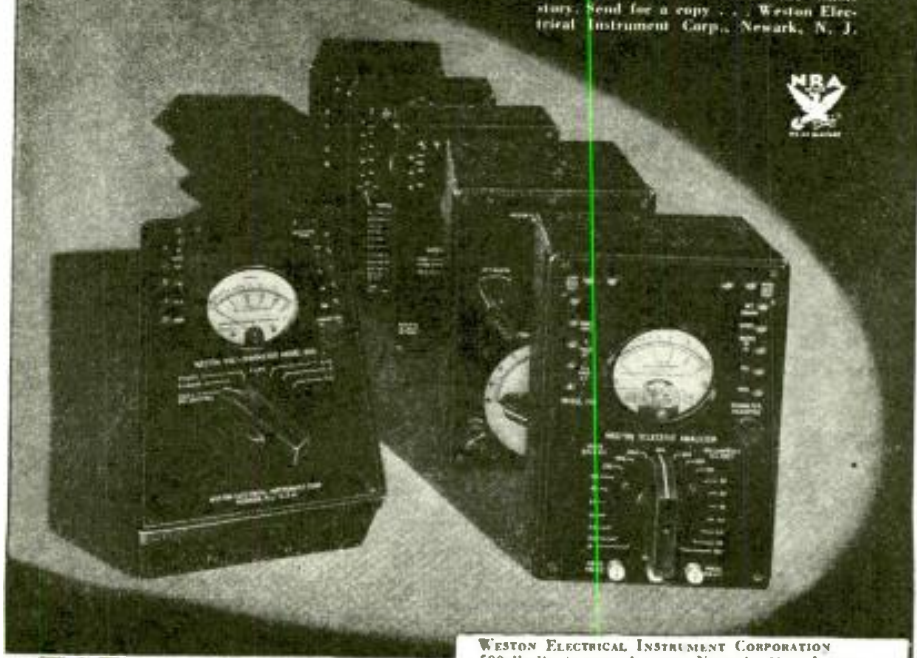

WESTON Radio Instruments

WESTON ELECTRICAL INSTRUMENT CORPORATION
599 Prelinchuyzen Avenue, Newark, New Jersey
Send Circular RA on Weston Radio Instruments.

Name

Address

Make MORE MONEY in RADIO with R.T.A. Professional TRAINING

Home study with R.T.A.—plus lifetime membership in our large, powerful association of radio service men—brings you up to date on all improvements in radio, television, sound engineering, and keeps you among the real money-makers in this expanding field. Unless you have this high-type professional training you will find it hard to get out of the poorly paid "tinkerer" class.



New-Type Set Analyzer Included

As part of R.T.A. training you get this up-to-the-minute Set Analyzer and Trouble Shooter. After a few easy lessons you are ready to use it for immediate money-making, competing with "old-timers" without fear. With this wonderful piece of equipment, backed by R.T.A. professional training, you need have no fear or worry over the future. Even though there should never be a new radio set constructed—or not another improvement in radio made—there are enough sets now in service that need frequent attention to assure you good money as an accepted Radio-technician.

Start Money-Making Quickly

R.T.A. Training is especially designed—and given you by one of the outstanding masters of radio technology in the world—to get you into the profitable end of radio work. It is not only easy, but practical down-to-earth work that makes you a money-maker in the business field in the shortest possible time. That's why your stars toward success! Write at once for all details about R.T.A. training. The Coupon below brings FACTS—astonishing ones that may open up a new, depression-proof future for you.

MAIL COUPON NOW!

RADIO TRAINING ASS'N. OF AMERICA,
4513 Ravenswood Av., Dep't. RCA-12, Chicago, Ill.
Send me all the FACTS about R.T.A. professional training together with information about the opportunities existing for R.T.A. Radiotechnicians today.

NAME.....

ADDRESS.....

New LYNCH RESISTOMETER FREE with 8 Handipaks



The New LYNCH Resistometer, the handiest service unit ever devised, can now be had FREE with LYNCH Handipaks. This is the most popular and practical service package ever offered.

NOW—in a jiffy—you can measure accurately the resistance value you are to replace—with the new LYNCH Resistometer.

Any value is obtained by the handy combinations made possible by LYNCH Handipaks. Each Handipak contains ten assorted One or Two Watt Resistors of the Metallized Type.

Complete Resistometer and four No. 1; three No. 2 and one No. 3 Handipaks, to Dealers and Servicemen; (List Price \$25.50) Your Cost \$12.60 Net.

Free Descriptive Folder
Upon Request

LYNCH MANUFACTURING CO., Inc.
51 Vesey Street, New York, N.Y.

SHORT WAVES

(Continued from page 346)

lator plate and grid coils, selected by gang-switch sections Sw5 and Sw6.

All three of these tuned circuits are tuned by the gang condenser C1, C2, C3, with hand-spread short-wave tuning accomplished by C4, the oscillator vernier condenser. Because of the relative broadness of the R.F. and first-detector circuits on short waves, narrow bands may be covered quite efficiently by simply shifting the oscillator tuning; one setting of R.F. and first-detector circuits being fully adequate for coverage of the 25, 31 or 50 meter broadcast bands, or the four amateur bands.

Capacities C27, C28, C29 and C30 are oscillator low-frequency pads, employed in the customary manner, to track the oscillator exactly 465 kc. away from the R.F. and first-detector frequency.

The Tubes

As the functioning of the 2A7 tube has been previously described in RADIO-CRAFT, there is no point in repeating this explanation here, except to point out that the oscillator grid leak, R11, is used to provide an additional stabilizing bias for the first-detector by bleeding its return through the detector bias resistor, R12.

Tubes S3, S4 and S5 are type 58 I.F. amplifiers coupled by I.F. transformers IF1, IF2, IF3 and IF4. These transformers are interesting as they are the first air-tuned types showing really good selectivity. This is entirely due to the use of a favorable LC ratio, something neglected in previous air-tuned I.F. transformers. Their permanence of setting, once aligned, is independent of temperature and humidity, and also of the amount of vibration encountered in ocean and domestic freight. They are tuned to 465 kc. and employ hitz coils of excellent Q (over 100, to be exact).

The visual resonance indicator, or tuning meter, is connected in the plate return of all three I.F. stages.

The second or power audio detector, S5, is a 5B tube used as a diode, since such application results in complete elimination of the distortion inherent in triode detectors. Its output is taken across the volume control R1, to the grid of the 5G first audio stage, S9. Tapped into R9 is the tuned circuit R6, L16, C14, which provides automatic tone compensation at low volumes by attenuating the middle register, resulting in the desirable apparent boosting of high and low tones.

S7 is an electron coupled 58 audio beat oscillator, set to heterodyne all I.F. amplifier signals when switch Sw8 is closed, thus permitting C.W. code reception, or the location of weak phone or broadcast stations by the heterodyne squeal.

Tube S8 is a 5G used as a diode A.V.C., operating to bias the I.F. control grids. Its effect is seen in Fig. 21).

Switch Sw9 is a phono-radio switch, allowing a phonograph pickup to be used with the audio amplifier. It is at the rear of the chassis, as is the head-phone jack J1.

The power supply is conventional, except that the fixed bias for the 2A3 power output tubes (S10 and S11) is obtained by placing the filter choke L18, in the negative return of the power supply; the current through it and voltage across it being held constant by the bleeder circuit R13, R14, R15 and R16.

Twenty-five watts for excitation of the giant speaker field is obtained by connecting the field directly across the high voltage power supply. It is not used as a choke as insufficient power could be obtained for it in this manner.

The Results

As to what such a design carefully executed will do, Fig. 2 tells the story—sensitivity, selectivity, fidelity, power output and A.V.C. (A, B, C and D, respectively) far superior to anything heretofore obtained. In the writer's laboratory in Chicago, located in a very noisy business district, showing in addition very weak signals indeed, it is possible every day to tune in Rome, Paris, Berlin, London and Madrid at such terrific volume that it must be turned down for enjoyment. Actually, the apparent increase in volume over the best previously available short-wave receivers is about twenty to one. Broadcast reception is just as good, relatively.

(All available circuit data appears in Fig. 1. If, at a future date, additional information becomes available—for instance, circuit constants—it will be published in RADIO-CRAFT. Technical Editor)

SHORT WAVES

Read "The Radio Month in Review," starting in this issue. Find out what is happening; learn of the new developments—and what they mean to you.

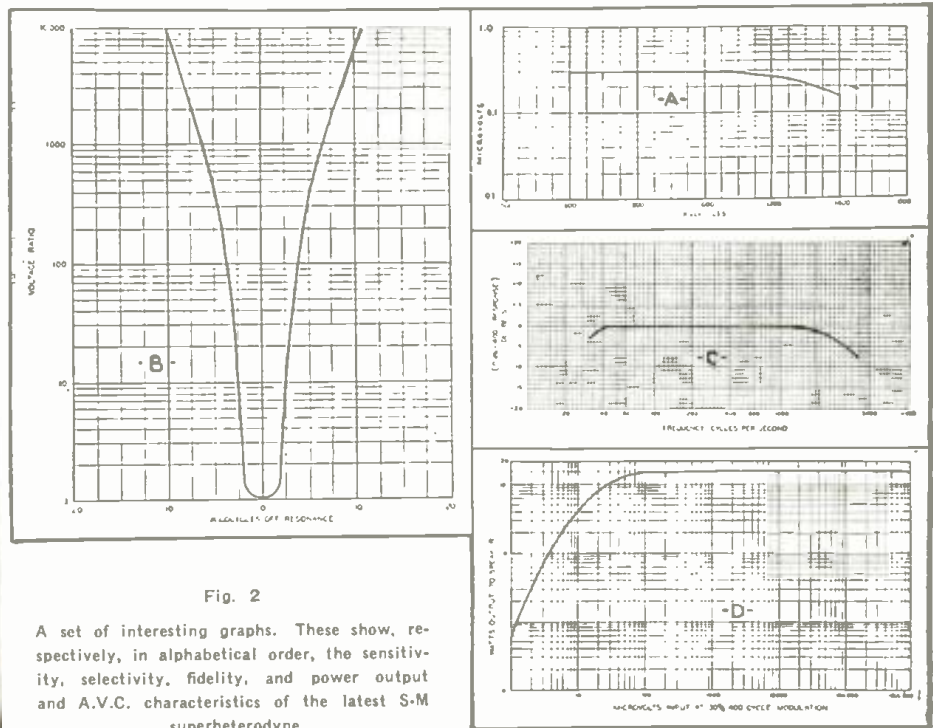

Fig. 2

A set of interesting graphs. These show, respectively, in alphabetical order, the sensitivity, selectivity, fidelity, and power output and A.V.C. characteristics of the latest S-M superheterodyne.

1934 SUPER HET.

(Continued from page 354)

formation on the connection of tuning meters that this interesting device had to be included. Be sure that this meter is bypassed to ground by means of the .1-mf., 400 V. tubular condenser.

(D) **The 2A6 Second-Detector Tube.** Another new tube of improved characteristics is used in the set, resulting in better A.V.C. action and greater gain. This increase in gain, plus the improved efficiency of the 2A7 alone, add to the over-all increase in sensitivity of the whole receiver.

(E) **Silent Tuning Switch.** Instead of the local-distance switch used in the 1933 model, a more interesting and useful trick is incorporated. This permits the tuning of the desired signal in absolute silence by using the tuning meter to establish the point of resonance and then "flip" the switch and presto the desired signal comes in without all the noise and objectionable back ground. This makes the Ultra-Modern Super just the kind of a receiver that is wanted in the home—tremendous gain, absolute selectivity and the minimum of noise.

(F) **Nine Tuned Circuits.** The same method of band-pass input from the antenna with two tuned circuits before the first R.F. tube is used, thus minimizing cross-talk which is always very hard to avoid in high gain R.F. amplifiers.

Brief Circuit Analysis

Those not familiar with the circuit as first developed will be interested in the following circuit description.

An examination of Fig. 1 reveals that 8 tubes are used in the new model. This is due to the fact that the oscillator and first detector functions are accomplished in the 2A7 tube. Starting at the antenna, a band-pass unit feeds the signal to the first R.F. stage. The plate circuit of the first R.F. tube is loaded by an R.F. choke. This choke resonates just below the broadcast band. Coupling between the first R.F. tube and the combination oscillator-modulator (2A7) is via the small mica condenser with a capacity of 50 mmf. This particular circuit combination tends to equalize the amplification over the broadcast band as far as the manual tuning circuit is concerned.

Oscillator tracking is accomplished by means of a series of padding condensers. If the proper coils and mica condensers are used there should be no trouble in lining up the oscillator tuning circuits. Improper values in the padding circuits will give trouble, but it

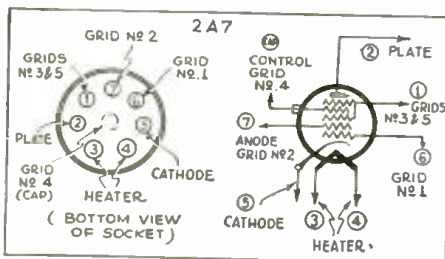

Fig. 2

Connection details of the type 2A7 tube.

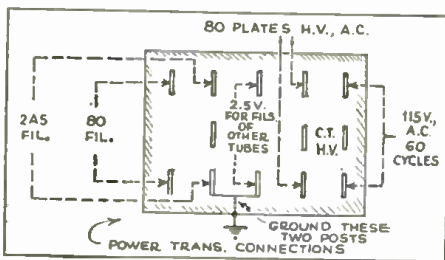

Fig. 5

Terminal connections of the power transformer. Compare the points indicated, with the schematic circuit, Fig. 1.

is the kind of trouble that can be avoided if the constructor will be careful in his selection of parts and of his wiring job.

The I.F. section of this receiver provides the major portion of selectivity and amplification and is that portion controlled by the A.V.C. voltage from the second-detector. As the receiver is equipped with A.V.C., the sensitivity of the two stages varies with the signal strength. Thus, between stations the noise level seems to come up and be disagreeable. As the set is tuned to resonance with a signal, note how the set seems to quiet down. That is where the tuning meter and the quiet tuning switch is so helpful.

A half-wave connection is used in the second detector stage so that the full advantage of the available R.F. signal voltage can be obtained for audio amplification and A.V.C. voltage.

Improved resistance-capacity filters are used to isolate the two I.F. amplifier tubes, thus resulting in greater stability.

Construction

The set is not difficult to construct although there are eight tubes employed; simply use care in mounting and soldering all electrical connections.

A cadmium plated steel chassis can be purchased fully drilled and folded in accordance with the above specifications.

Mount the sockets, band-tuner coil, electrolytic condensers, four gang tuning condenser, and the power transformer on top of the chassis as shown in the photographs of the actual receiver. Place all tube shields in their respective sockets, and after this is done, mount the I.F. transformers. Be sure that the third I.F. transformer has its control-grid lead running down through the chassis so as to connect to the collectors of the 2A6 second-detector tube. All other components are mounted under the chassis. The two 1 mf. condensers are bolted to the chassis as well as the push-pull input A.F. transformer and the small filter choke. The rest of the small 1 W. resistors and the small tubular condensers are held in place by the wiring; therefore, it is necessary to make good mechanical connections before soldering these units in place.

Wiring

Use good wire—poor wire and poor insulation should be avoided if the best results are to be obtained. A No. 11 gauge wire is ideal for the filament circuits and should be well insulated. The balance of the wiring can be done with a well insulated No. 18. Solder with a good hot iron and clean all connections with alcohol.

Wire the filament circuits of all tubes first, twisting these leads together. Then wire the plate voltage supply, including the rectifier tube, electrolytic condensers, choke and the socket used for connections to the speaker field and the output transformer. After this is finished, complete all plate and plate-return circuits to their respective sockets and high voltage supply terminals.

The grid circuits are wired in last and due to the simplification of the newer circuit this is an easy job. The power transformer wiring diagram will be found in Fig. 5.

Speaker Selection

As the speaker field is a portion of the plate supply filter circuits, some limitations must be set on the resistance of the speaker field used. The circuit of the receiver has been so designed that satisfactory operation can be obtained with consideration variation in the resistance of the field winding without upsetting the voltages used throughout the set.

Do not use a speaker field with a resistance less than 1000 ohms, or greater than 2500 ohms. The effective plate voltage with a 2500 ohm speaker field will be just under 200 V.; speaker fields of 1800 and 1400 ohms are ideal to use with this set. If the field resistance is dropped below 1000 ohms, the filtering action will be impaired and the applied voltage will be too high.

The speaker must be supplied with an output transformer to match the two pentodes in the output stage. The transformer used with the 47 type tubes of the original circuit is fine for the 2A5 output tubes.

The ACCURACY of this Newly Designed OSCILLATOR Is Outstanding!



No. 550 Oscillator

is one of the serviceman's most important instruments. This signal generator furnishes a modulated signal of constant frequency for the alignment of all radios. It is used to align r.f. gang condensers, locate defective r.f. transformers, adjust i.f. transformers, check oscillator stage, compare gain in tubes and determine the sensitivity of a receiver. Range is 550-1600 broadcast and 110-540 intermediates. No harmonics need be calculated by the user. Each fractional frequency is hand calibrated—actually typewritten on an individually hand made chart.

YOUR JOBBER CAN SUPPLY YOU

... with the No. 550 Readrite Oscillator at the Dealer's Net Price of only \$21.00. See him today.

READRITE METER WORKS

86 College Ave.  Bluffton, Ohio

Send Coupon for Facts!

READRITE METER WORKS
86 College Ave.
Bluffton, Ohio

Gentlemen:

Send me catalog on Readrite Oscillator No. 550, as well as folder giving proofs of Readrite Leadership.

Name

Street Address

City State

NEW AMAZING AERO INTERNATIONAL

ALL WAVE
11 TUBE
SUPER
De LUXE



Here now! World Wide Reception. No plug in coils. Automatic volume control—100% shielding—new superphonic tubes. Get ALL the programs—short wave and broadcast. Buy now at this remarkably low price.

Completely Assembled With 2 Matched Full Dynamic Speakers
\$29.75
Tubes \$7.75

AERO WORLD WIDE



1-Tube Short Wave Set for Head-phone Operation
\$5.95

Enjoy the thrill of listening DIRECT to Buenos Aires, London, Berlin, Paris, and other broadcasting stations throughout the world, via SHORT WAVES. The AERO WORLD WIDE RECEIVER gets 15 to 550 meters. For the last seven years this little wonder set has been one of the biggest sellers in the Short Wave Field.

Complete line of radio sets and transmitting apparatus
Write for FREE Catalogue

CHARLES HOODWIN CO.
4240 Lincoln Ave., Dept. H-15 Chicago

Please send your NEW 1933 FREE CATALOGUE.

Name.....

Street.....

Town..... State.....

THE "DEPENDABLE"

New Model 303A

TUBE TESTER

Will Always Be Up-To-Date



PRICE ONLY
\$18.75

net to Dealers and Servicemen

List \$35

The Dependable defies competition, starting where others leave off. Certainly it tests every new tube—more than 130 different tube types are indicated on the etched panel. Furthermore, it provides for testing 50 more new type tubes. Perpetually up-to-date, the new 303A Tube Tester has many other features. Uses high-quality D'Arsonval moving coil meter—Tests all tubes more accurately and scientifically—quicker and easier—Only two selector switches to adjust. Has short tester, molded sockets including large and small 7-prong sockets, pilot light indicator, gas test, second plate for all rectifiers, line voltage adjustment, light, compact, good-looking leatherette carrying case. Complete Knock-Down Kit with instructions \$14.75.

New Model 101 MULTITESTER

Voltmeter—Ohmmeter—Milliammeter

Includes Triple Range Ohmmeter, 1/2 to 2 million ohms, complete self-contained; Four-Range Voltmeter, 0-5-50-250-750 volts at 1000 ohms per volt; and Triple Range Milliammeter, 0-5-250-750 uis. Automatic Selector Switch D'Arsonval type Meter—Elovely Etched Panel—Test Prods.—5 1/2 in. by 8 3/4 in. by 4 in. Case.
\$20 net to dealers and servicemen—List \$37.50
Also Available in Knock-Down Kit Form \$15 net

Send for free data sheets. Dept. RC

RADIO CITY PRODUCTS CO.

48 WEST BROADWAY NEW YORK, N. Y.

Testing

After the set has been completely wired and checked, adjust the I.F. transformers to 175 kc. by means of an oscillator. After this is done, connect the set to an antenna and adjust the oscillator padding condensers for maximum sensitivity over the broadcast band.

The adjustment of the oscillator padding units is the most important thing to do and it must be done right.

A new type dial was used by the author so that the light from the tuning meter would illuminate the transparent scale of the tuning dial and concentrate all controls in the center of the receiver.

The specifications for the small bracket, holding the manual volume control mounted in front of the 2A6 second detector, will be found in Fig. 3. Mounting this control in this manner shortens leads and makes for greater circuit stability. The tuning meter is mounted to the end plate of the tuning condenser by means of the two small metal brackets and soldered between the meter flanges and the metal brackets.

If phonograph pickup is desired, follow the circuit diagram of Fig. 4. Note that a step up transformer is specified and that a 200 ohm pickup is used so that ample volume will be obtained from records. Mount the phonograph pickup matching transformer near the pickup if possible. A switch can be included on the rear of the chassis to change over from radio to phonograph reception.

With the few small extra items and the changes in the circuit properly made, the owner of the Ultra-Modern Super will have a receiver that will be hard to beat for all round performance.

Revised Parts List

- One four gang tuning condenser 365 mmf., type 6654, C1, C2, C3, C4;
- One condenser, mica, 750 mmf., type No. 6636, C8;
- One condenser, mica, 50 mmf., No. 6629, C9;
- Three condensers, mica, 250 mmf., No. 6632, C11, C22, C19;
- One condenser, mica, .006 mf., No. 3148, C27;
- One trimmer condenser No. 2883, C10;
- One condenser, 1 mf., type G1100, C6; type G1100, C24;
- Nine Aeratest cartridge condensers, .1-mf., 200 V., No. 5637, C5, C6, C7, C12, C13, C14, C15, C16, C21;
- One Aeratest cartridge condenser, .1-mf., 400 V., No. 5646, C17;
- One Aeratest cartridge condenser, .25-mf., 200 V., No. 2835, C18;
- One Aeratest cartridge condenser, .02-mf., 400 V., No. 5641, C20;
- One Aeratest electrolytic condenser, 10 mf., 25 V., No. 6645, C23;
- Two Aeratest electrolytic condensers, 8 mf., 500 peak V., No. 5308, C25, C26;
- One Aeratest kit of band-pass and detector-oscillator coils, No. 6645, L1, L2, L3, L5, L6;
- One Aeratest R.F. choke, No. 2871, L4;
- Three Aeratest 175 kc. transformers, No. 5358, I.F.T. 1, I.F.T. 2, I.F.T. 3;
- One volume control with power switch, type G175, R16;
- One Federated special chassis, No. 7297;
- One Aeratest power transformer, type 2527; PT;
- One Aeratest choke, 30 hy., 75 ma., type 2505, CH1;
- One rotary snap switch, S1;
- One Aeratest push-pull input transformer, type 5834, T1;
- One Aeratest tuning dial, type 4047, for large condenser shaft;
- Five screen grid clips;
- Five Aeratest tube shields, type 7173;
- One 4 prong socket, marked 80;
- Two 6 prong sockets, marked 2A5;
- One 5 prong socket, marked speaker;
- Three 6 prong sockets, marked 58;
- One 7 prong socket, marked 2A7;
- One 6 prong socket, marked 2A6;
- One Readrite tuning meter, type 126, 0-10 ma.;
- One Alden short plug and cap, type 5869;
- Six ft. power cord and plug;
- One antenna-ground strip;
- One Aeratest resistor, 500 ohms .5-W., type 5860, R1;
- Three Aeratest resistors, 350 ohms .5-W., type 5860, R5, R7, R9;
- Two Aeratest resistors, 20,000 ohms 1-W., type 5860, R4;
- Three Aeratest resistors, .5-meg., .5-W., type 5860, R6, R8, R12;

- One Aeratest resistor, 30,000 ohms, 1-W., type 3500, R2;
- One Aeratest resistor, .25-meg., .5-W., type 5860, R13;
- One Aeratest resistor, 5,000 ohms, .5-W., type 5860, R14;
- One Aeratest resistor, 200 ohms, 2 W., type 5185, R15.
- One potentiometer, .5-meg., without power switch, type 6160, R11;
- Three type 58 tubes;
- Two type 2A5 tubes;
- One type 80 tube;
- One type 2A7 tube;
- One type 2A6 tube.

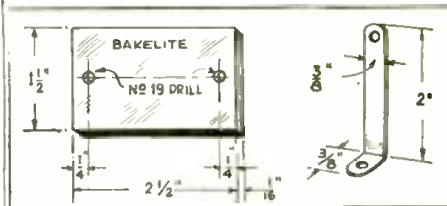

Fig. 3

Details of the mounting bracket.

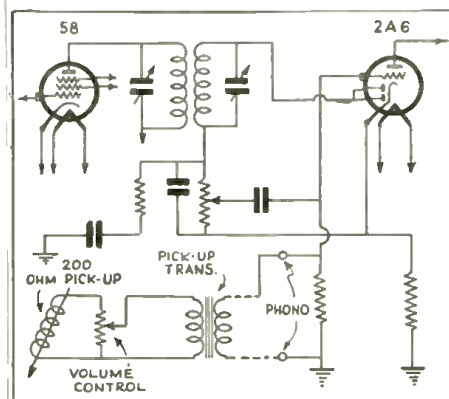

Fig. 4

Connecting a phone pickup into circuit.

OPERATING NOTES

(Continued from page 351)

connection for this condenser. A jumper soldered to the condenser can, and connected to the chassis, fixed this condition. Also this set would suddenly cut off, and come back with a bang if the chassis was tapped. This was finally found to be due to poor soldering on all three grid caps; a good hot iron soon cleared this up. These points are illustrated in Fig. 4.

BYPASS CONDENSERS IN SILVER-30

A Silver model 30 (chassis), an early screen-grid set, had no detector plate voltage. However, a check-up of the detector circuit showed nothing wrong, (apparently) so the detector tube was suspected of internal shorts in condition which caused the same effect in other sets; but the tube worked O.K. in another set. It was then noticed that when the tube was taken out of the socket there was plate voltage. This indicated that the plate circuit was the cause. So, with the set turned on, the detector circuit was carefully checked over and the trouble located in the cathode circuit. The bias resistor is bypassed by two condensers (early models), and one of these broke down, intermittently, which made it difficult to locate the trouble. (See Fig. 5.) Later models of this set had a change in the bypass condenser wiring.

New data concerning E. Franklin Sarver's "Treasure" finder described in the July, 1933 issue of RADIO-CRAFT, is contained in the November issue, page 294. Please report the results you have obtained.

STAGE TESTING

(Continued from page 348)

Four Test Systems

There are four basic trouble shooting procedures, namely: (1) the set analysis, (2) the point-to-point voltage tests, (3) the point-to-point resistance tests and finally (4) the direct stage-by-stage elimination method. All four methods have their faults and good points. Modern equipment has been developed so that any one of these methods may be used on the old and the most recent receivers. In my opinion, the method most suited to the needs of the well-trained Service Man is the "direct stage-by-stage elimination" method. Essentially, it is an extension of the effect to cause analysis and is practically obsolescence proof. Being direct, it eliminates useless steps—it therefore is a time saver and a money producing procedure.

If a receiver is dead or has interference (noise, squeals or distortion) it is natural to ask yourself—"where in the receiver does this defect take place?" Realizing that a receiver consists of R.F. amplifiers, mixers, oscillators, detectors, power amplifiers and control tubes in a stage after stage or chain arrangement, the logical procedure would be to isolate that stage which breaks the chain.

Perhaps the oldest technique is to tap the grid of the second-detector (we will confine ourselves to supers, as they are the most involved). A thump or squeal from the output would normally indicate a satisfactory audio system. Failure to get this indication would call for an A.F. test. Some Service Men quickly jerk out and return an A.F. tube from its socket; a click should be heard. They do this in spite of the fact that they may break down the audio transformer; a better plan is to use a plate break-in adapter and headphone, listening in the audio stages one after the other while touching the grid of the detector. Assuming that the A.F. amplifier and the second-detector are in order, the Service Man may proceed to open the grids of the I.F., mixer, oscillator and R.F. tubes and listening for an output click. (Disconnect quickly the top cap connection or jerk out the tube.) Going from an output signal to no output naturally indicates a faulty stage at the last tested.

A more modern procedure, less likely to give incorrect indications and particularly valuable in tracing down distortion, makes use of a variable-frequency-modulated service oscillator and an output meter. In this case the output meter is connected from plate to plate of the output tubes or plate to chassis of the output tube and the test signal applied to the control-grid of the second-detector. A perfect audio system will be evident by an A.F. sound from the speaker and an output meter reading. Failure to get any indication definitely denotes an A.F. system defect. In this case, the output indicator may be progressively connected to the plate-chassis of the detector; first A.F. stages; etc. If the oscillator output is limited, it may be necessary to resort to the phone-plate break-in adapter indicator.

Consider the A.F. system in good condition. Set the signal generator to the intermediate frequency and return the output indicator to the output. Progressively connect the signal generator to the grid-chassis of the various I.F. stages and proceed systematically to the I.F. amplifier input. If the I.F. stage is in order, you will continue to get an output reading which will increase in value as you proceed to the next stage. In going from one stage to the next, if you go from "signal" to "no signal" or to "no increase" in output you can be reasonably sure that you have passed through the defective stage. As a further check, connect the signal generator to the plate-chassis of the tube in question. "No signal" will indicate a defect in the coupling to the stages tested and found O.K.

Suppose we find the I.F. system intact. The next move is to connect the signal generator adjusted to intermediate frequency, to the first-detector. If the mixer is working, you should still get an output reading. Next set the signal generator to the 550-1500 kc. range. In tuning the signal generator to the setting of the station selector dial, an output signal will indicate an operating oscillator; and no signal—a defective oscillator. Of

Would You Let a Plumber Operate?

IF you need an operation you hire a surgeon. Why not be as careful about your resistors?

Electrad has specialized in resistors since radio began. Use Electrad Resistors for SAFETY and SURE RESULTS.

TRUVOLT The Only RESISTOR of Its Type

No other resistor combines so many advantages:

- 1—Larger wire and patented air-cooling mean long life.
- 2—Double spiral winding insures better electrical contact.
- 3—Sliding Clips permit accurate voltage adjustments.
- 4—1,000 volt insulation and fibre protective guard.

All Standard Sizes



10-WATT RESISTORS

That Stand Out From the Crowd

Electrad 10-watters are unique for their electrical and mechanical features. Monel Metal contact bands and lugs resist oxidation and strains under firing. Vitreous enamel insulation does not absorb moisture.

Rapid heat dissipation, long life and economical priced. Only 35c each, list.

Three sizes—67 values



FREE

VEST-POCKET VOLUME CONTROL GUIDE

Write for FREE Copy



Write Dept. RC-12 for FREE GENERAL CATALOG and VEST-POCKET VOLUME CONTROL GUIDE.

175 Varick St. New York, N.Y.
ELECTRAD

N E W

mobile public address system

FOR SOUND TRUCKS

or semi-permanent installations

Small, compact 6 volt battery operated outfit for use where line current not available (or with power pack can be used on A.C. line). Tremendous volume, exceptionally powerful. True tone or voice or music whether radio, phonograph or direct sound; mixer switch allows reproducing voice and music together. Comes complete with tubes, 2 twelve inch amplifiers, matched dynamic cone speakers, "mike," and 30 feet of microphone cord, polarized plugs, ready for immediate installation. Very moderate price. For specifications, price, all details

Write for Bulletin B-79

THE WEBSTER COMPANY

3823 West Lake Street
CHICAGO

World-Wide Two Tube Short Wave Receiver



12,500 Mile reception record established! Tunes from 15 to 200 Meters. Gets foreign broadcasts, police calls, airplanes, amateurs, etc. **WRITE!** Complete KIT (no drilling) with clear instructions to build this remarkable 2 tube receiver.....\$4.75 Dry cell or AC model. Send \$1.00. Balance C.O.D. Satisfaction Guaranteed! Send for FREE Short Wave Catalog

Harrison Radio Co., Dept. R12, 142 Liberty St., N.Y.C.

Now 108 PAGE free
1933 RADIO
CATALOG
Replete with BARGAINS GALORE for DEALERS—SERVICEMEN—AMATEURS
Send for Your Copy TODAY!
TRY-MO RADIO Co. Dept. C-12
83 CORTLAND ST. NEW YORK CITY

SPRAYBERRY'S Training Gets More Jobs for Radio Men!

Here's a real constructive Radio Service Course which gives the Practical Mechanics of Radio Service. It's a training which "go-getting" service men will find adding more dollars to their weekly income.

There's no Radio service course, so practical, yet so thorough and essential to all Radio men.

This highly instructive, advanced training, covers set testing from the simple "analyzer" method to the complex "point-to-point" method. Instructive lessons cover repairing Superheterodyne circuits, A.V.C. and Public Address, Auto-Radios, Battery and D.C. sets. Practical methods of testing Condensers, Resistors, Transformers, Tubes and Speakers are completely described. Location and elimination of various receiver troubles are explained. Latest receiver tubes and sockets are discussed, as well as analyzed. And most important is the instruction on "Set Analyzers." It shows how to keep every analyzer up-to-date—adaptable for any circuit.

Complete course at a price every serviceman can afford to pay.

Mail Coupon Today!

F. L. SPRAYBERRY RCI 2
132 Bryant St., N.W., Washington, D. C.
Gentlemen: Please rush to me the complete details of your new course "PRACTICAL MECHANICS OF RADIO SERVICE" of 28 lessons.

Name

Address

City State



Books and lectures on the marvelous accomplishments of the Photo-electric cell must inspire you, but only by experience with the actual device can you get the FEEL of a Photo-cell; only by owning and working with the tools of Photo-electricity (a complete kit) can this science become a powerful reality rather than the intriguing mystery that it must be to you now.

Years of experience manufacturing Photo-cells and allied instruments have placed us in a position to supply the most dependable apparatus known. The Kit we offer consists of only the highest quality merchandise; a Photo-electric cell, amplifying tube, magnetic relay, condenser, resistors, socket; everything that is essential for the ideal unit, though your problem is to control illumination, detect burglars, count articles in production, guard machinery or accomplish any of the innumerable feats which are practical for Photo-cell control.

Our price is an achievement in itself.
\$8.00 the complete kit.

THE CLARK INSTRUMENT Co.
CAMDEN, N. J.

TAUREX Meter Rectifier MADE FOR METERS

Converts any D.C. Milliammeter into a Sensitive A.C. Meter—Size 1/2 in. by 1/2 in.—Fully Guaranteed. Can be used in Set Testers, Analyzers and for many other purposes. See article on Universal Analyzer in Oct. issue of Radi-Craft. TAUREX will be shipped postpaid promptly upon receipt of \$3 (check or money order—no order C.O.D.) and pay instantly. Priced complete with Diagrams and Instructions.
The Taussig MASTERDIAL—installed on your 0 to 1 D.C. Milliammeter enables you to read Sixteen A.C. and D.C. Voltage, Resistance and Capacity Ranges. Price \$2.75 postpaid.
Lee Taussig, 3245 37th St., Long Island City, N.Y.

course, the oscillator may not be correctly padded, so you should turn the signal generator through at least 100 kc. From there you would apply an R.F. signal to the grid input of the various R.F. stages until you reach the aerial and ground terminals.

The outstanding fact in this test is that in following through the stages you will go from a signal to no signal. For the sake of completeness you would isolate the defect in the output or input of the stage under question. In screen grid tubes, the grid-chassis connection is easily made. In the case of tubes where the grid electrode is one of the prongs or in the case of the plate-chassis connection, a simple 4-, 5-, 6-, and 7-prong wafer adapter having the prong connection extended by a flexible strip will be needed.

Once the defective stage is located, the Service Man may follow any of the other three methods of stage analysis.

For stage by stage servicing there is now available a commercial instrument, the Trip-lett service oscillator illustrated in Fig. A, which incorporates the necessary combination signal generator and multimeter housed in a convenient carrying case; the principal dimensions are 16 1/2 x 4 1/2 x 7 3/4 in. and its weight is 10 lbs., with batteries, accessories and tube. Figure 1A is the circuit diagram of the oscillator and Fig. 1B, the schematic of the multimeter.

Referring to Fig. A we observe:

1. A compartment for storing the accessories. This section, located on the left, includes: (a) a flexible shielded cable with two insulated and shielded probes on one end and two insulated pin-jack plugs on the other. These are used for connecting the signal generator to any stage—either permanently or by probing. (b) Two long, flexible cords, one red, the other black, each having sharp, pointed probes and an insulated pin-jack plug; (c) Two output leads, one red and the other black, each having insulated pin-jack plugs. (d) Two universal clips with special spring clasps to fit on any probe point or pin-jack plug. These clips allow quick connection to the chassis or cap of screen-grid type tubes. And (e) two universal socket prong connectors which fit any lead mentioned above and slip onto any tube prong. With the latter four accessories, the signal generator or the multimeter may be connected to any tube electrode in the chassis.

2. The Signal Generator. This unit has two ranges which are controlled by the D.P.D.T. toggle switch. The I.F. range tunes from 100 to 270 kc.; its second harmonic extends the frequency range to 540 kc. The broadcast range includes 540 to 1600 kc. Below the main tuning dial is the attenuator which feeds the GND. and MIN. jacks on the left. When the oscillator cable is inserted into GND. and MA. jacks, a strong uncontrollable signal is obtained which is of particular value for insensitive and out of line receivers. The toggle on the right transforms the modulated signal generator to an unmodulated state. An unmodulated oscillator is necessary to calibrate the signal generator by beating with a broadcast signal fed to the input of a sensitive receiver. Usually an unmodulated signal is necessary to get a squeal. The oscillator must be so designed that frequency shift from the unmodulated to the modulated state is negligible. An unmodulated oscillator is extremely valuable in aligning exactly at a given I.F. value. For example, to align an I.F. exactly at 175 kc., adjust the unmodulated oscillator to beat with a 700 kc. broadcast exactly between the two squeals. Without disturbing the oscillator, proceed to align the I.F. system, using as an indicator a milliammeter in the plate circuit of the second-detector. An unmodulated oscillator is also valuable in checking modulation hum. The final switch on the signal generator is the OFF-ON toggle; it is protected by an ON spring which prevents closing the carrying case when the oscillator is turned on.

3. The Battery Container. In the center is the battery container (having the oscillator calibration curve cemented to the top.) Both the oscillator and batteries are enclosed in their own, special alloy, shielding box.

4. The Multimeter. On the right is the multimeter incorporating a multi-range D.C. voltmeter, D.C. milliammeter, A.C. voltmeter, A.C. milliammeter, ohmmeter, and output meter. The basic instrument is an 0 to 500 micro-

ampere, jewel-bearing, D.C. moving-coil meter; by means of a full-wave copper-oxide rectifier it is converted to an A.C. device. In either case the meter is so "loaded" that it is basically a 1-ma., A.C. or D.C. scale. By means of a set of multipliers, the voltage ranges are 0-15, 0-150, and 0-750 V. The lower toggle switch is the D.C. to A.C. change-over. Any range is selected by means of the main selector switch. The ohmmeter is a 0-1500 and 0-1.5 meg. device. The instrument is so designated that the lower range is easily read up to 1,000 ohms and down to 1 ohm! The high-range ohmmeter reads distinctly from 1,000-0.1-meg. and then in terms of .25-, 0.5-, .75-, 1.0, and 1.5 megohms. On the left is the zero-adjustment knob. The five remaining positions on the main selector provide 0-150, 0-15, 0-1.5 D.C. ma. and 0-150 and 0-15 A.C. ma. measurements. To the right of the meter are the output jacks. The red lead wire inserted in "+ chassis" is a fixed connection. The black lead plugs into the "-" jack for D.C. volts, amperes, and resistance measurements. It is plugged into the second-from-the-top jack for A.C. volts and current measurements and the upper jack for output measurements, which are in this instrument high, medium, and low. All D.C. and low-range ohm readings are imprinted black on the meter scale. All A.C. scales are red. The ohmmeter readings are followed by red zeros which must be included in the readings when using the high ohmmeter range.

This "perpetual" tester has many fields of application. In addition to its application in the fundamental stage-by-stage elimination method it may be used to:

- Test tubes. The signal generator is connected to the receiver input and the output meter to the plate-chassis or voice coil of the receiver. Adjust the receiver to about 1200 kc. and tune the signal generator until maximum deflection is obtained. Adjust the signal generator attenuator or the output range to give an output reading about mid-scale. In the instance of A.V.C. receivers, adjust the signal generator to well below the "threshold" sensitivity. (The point where increased receiver input causes little output rise.) Exchange the receiver tubes for new tubes known to be in good condition. A marked rise in output indicates the need of a new tube. A.V.C. tubes may be selected with this set-up. Remove the old A.V.C. tube. Set the signal generator to minimum output and insert an A.V.C. tube to give minimum reduction in output. Test for threshold action. Gassy tubes in this set will show up with creeping of the output indication.
- Align R.F., oscillator and A.F. circuits.
- Neutralize sets.
- Make point-to-point resistance trouble shooting tests by using the ohmmeter section.
- Make point-to-point voltage trouble shooting tests.
- Roughly estimate sensitivity and selectivity of receivers.
- Check for shorted turns. Using the A.C. milliammeter and a suitable shunt, an 0-5 A. meter may be constructed which if inserted into the primary circuit of the power transformers will indicate shorted turns.
- Determine capacity, through the use of the A.C. milliammeter.
- Equip a test laboratory, since the basic instruments may be used in special laboratory testing circuits.

(j) Build up a selective analyzer. The details of such a system are clearly indicated in Fig. 2. By inserting the multi-meter leads to any two tip jacks, the cable and adapter into the receiver and the tube in the selective analyzer, any voltage between any two electrodes in the receiver may be measured. Inserting the multimeter leads into the twin tip jacks, current in that lead is measured. Removing the tube and turning off the power switch of the receiver, the point-to-point resistance from the tube sockets may be measured.

Radio manufacturers have standardized tubes by numbering the prongs of 4-, 5-, 6-, and 7-prong tubes, as shown in Table 1; the electrode connections are made to prongs 1, 2, 3, etc., to Te (top cap). This table should be used with the selective analyzer until the system becomes second nature.

This selective analyzer may be used to test tubes by the grid shift method.

TABLE I

Base Connections of Vacuum Tubes

The following table shows the type of base and the base connections of a selected list of receiving tubes. The following symbols are used to indicate the connections:

H—Heater, F—Filament, K—Cathode, G—Grid, P—Plate, D—Diode Plate.

When more than one grid is brought out to terminals the notation G₁, G₂, etc. is used, G₁ is the grid nearest the cathode or filament and the numbering runs consecutively toward the plate. When the tube is a double structure such as a double triode, the symbols G₁, Pt₁, etc., are used to indicate which elements work together. In the case of diode rectifiers, the symbols K₁, Pt₁, etc., are used. In the case of co-planar or twin grids, the notation GA and GB is used.

AUTO RADIO

(Continued from page 341)

and guide pin on the socket and the plug. From the drawing you will see that this guiding slot and pin is always located between terminals 6 and 7. Keep this in mind when making connections to either the socket or the plug. The information given in Fig. 9 should make the connecting of the plug wires, and also the connecting of the chassis socket wires, easy to understand. On this drawing all the terminals are numbered and all the wires coming to the terminals are specified with a color code.

Referring to Fig. 3, you will find a general layout of the whole radio set mounted into the chassis box. The chassis is slipped over the chassis locating pins, one of which is shown in one corner of the box. The chassis box packing, part No. 8 (Fig. 10A) made of soft rubber, is put on top of the box and the box itself is closed by using the chassis box cover, part No. 3 (Fig. 10B). When tightening down the chassis box cover, the tube shields will compress, holding the whole chassis with parts tightly in the box. On this drawing, Fig. 3, the tube cushion rubber rings, part No. 2 (Fig. 11A), are also shown mounted over the tubes within the tube shields. These rings will prevent the tubes from rattling and coming loose in their sockets. By using such an assembly in the chassis box, the chassis will be securely mounted in the box and prevented from shifting either horizontally or vertically; and by removing the chassis box cover, the chassis can be taken out of the box without going under the car to remove any screws which might hold the chassis in position. The chassis box cover with packing will make the whole layout dust and water proof.

When making the chassis box cover you will be guided by the drawing for part No. 3 (Fig. 10B); the cover consists of No. 16 gauge (.062) sheet steel, cadmium plated or enameled. The twelve holes for the screws are countersunk on one side to provide a seat for the 8-32 flat head screws. In Fig. 3 you will also see the junction box mounted to the chassis box and the cable wires connected to the chassis by means of the cable plug. A packing, part No. 11 (Fig. 11B) is used with the junction box; again assuring a tight, dust, and damp proof seal. The assembling of the oscillator and I.F. coils can also be seen in Fig. 3, as well as the location of the input transformer, which is mounted on the chassis by means of two 8-32 self-tapping screws. The flexible condenser adjusting cable is brought through the box and fastened to the box by the tightening nut furnished with the remote control unit. The flexible shaft cable is brought around the condenser wheel groove and fastened to the condenser wheel by the screw on the wheel itself. The assembly of the condenser wheel with the tuning condenser is shown in Fig. 12. The condenser might not be provided with the two holes 1/8-in. apart as shown and should then be drilled to the dimensions shown. These two holes are required to join the condenser spring and spring cup with tuning condensers. One end of the spring is slipped through the slot on the spring cup and the cup is then brought over the condenser shaft and knob, and the two fingers on the cup are slipped through the two 1/8-in. holes and bent over on the inside of the tuning condenser; thus fastening the spring to the condenser. The other end of the spring is then placed on one finger of the condenser wheel, the spring now being wound to come within these fingers on the wheel, and then the wheel is slipped on condenser shaft. Turning the wheel in the right hand direction will tighten the spring. The set screws on the wheel can now be tightened on the shaft and the spring will have the tendency to hold the condenser in an open position. In this open position, the flexible shaft tightening screw should point upward to make it easily accessible for tightening purposes.

Part No. 5 (Fig. 13) shows the motor-generator box and cover. This box can be used also when it is desired to mount the motor-generator in the rear of the car floor. The dimensions shown on this drawing will fit one commercial make of motor-generator. On one side of the box you will see a 7/16-in. diameter hole provided for a rubber grommet and serving as a lead-in hole for the motor-

FREE!



New 64-PAGE HANDBOOK of Servicing facts and Short-cuts!

Here's a new free booklet every service man will find invaluable! Contains practical information and servicing tips that service men all over the country have sent to us. Shows how to solve many tough problems . . . saves you time and money!

Mail the coupon today and get your copy. We'll also put your name on the mailing list for Sylvania's free monthly Service Bulletin. It gives additional service tips each month . . . and tells how you can earn free tubes for your own suggestions!

HYGRADE SYLVANIA CORPORATION

FACTORIES
Emporium, Pa.
St. Marys, Pa.
Salem, Mass.
Clifton, N. J.



MAKERS OF
Sylvania Tubes
Hygrade Lamps
Electronic Devices

Sylvania
THE SET-TESTED RADIO TUBE

Hygrade Sylvania Corporation
500 Fifth Avenue, New York, N. Y.

Please send me your free booklet "Service Hints" and your free monthly Service Bulletin.

Name

Name of Firm.....

Address

CityState

114

MILES Announces the latest SOCKET MIKE

(Patent Pending)

In All the World There's No Mike Like This!

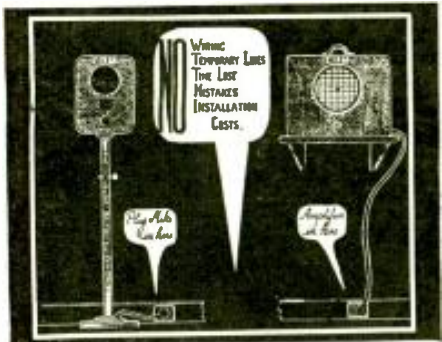

MILES SOCKET MIKE (patents pending) will operate with—(1) Any Standard Radio Receiver; (2) Any Standard Power Amplifier with Built-in Speaker.

MILES SOCKET MIKE AND SOCKET AMPLIFIER plug directly into any 110 volt A.C. lighting circuit.

MILES SOCKET MIKE and RADIO RECEIVER or AMPLIFIER are operated as two separate units. They are designed to function at widely separate points within a building thus enabling you to speak from the bottom floor to the top floor or from room to room without the use of wires.

Contact between MIKE and AMPLIFIER or RADIO RECEIVER is automatically established when you plug them in at your regular service outlets.

Installation is virtually INSTANTANEOUS. No wiring; No temporary lines; No time lost; No mistakes; No installation costs; No additional equipment needed.

Details on Request Depr. RC

MILES SOCKET MIKE CO.
244 West 23rd Street New York, N. Y.

THE NEW SHALLCROSS A.C. UTILITY METER No. 689



CAPACITY
.0005 Mfd. to 10 Mfd.

INDUCTANCE
.5 Henrys to 10,000 Henrys

RESISTANCE
25 ohms to 5 megohms.
A.C. voltage ranges
0-10-125-500-1000
1000 ohms per volt.

This instrument is very easy to build. The important parts required are a 1-milliamper A.C. (rectifier type) meter and the SHALLCROSS Resistor Kit No. 685 with meter scale. Send 6c in stamps for Bulletin 685-P describing this useful test instrument.

SHALLCROSS MFG. COMPANY
Electrical Measuring Instruments
and Accurate Resistors
700 MAC DADD BOULEVARD
COLLINGDALE, PA.

PRACTICAL RADIO ENGINEERING

An opportunity for
RADIO MEN to en-
large their scope of
training.

Whether elementary radio principles or advanced subjects, sound applications or practical radio engineering, RCA Institutes is prepared to give you the instruction you need.

RESIDENT SCHOOLS NEW YORK AND CHICAGO
with modern standard equipment

EXTENSION COURSES FOR HOME STUDY
under convenient "no obligation" plan.
Illustrated Catalog on Request

RCA INSTITUTES, INC.

Dept. RT-12

75 Varick Street, New York
1154 Merchandise Mart, Chicago

generator cable. The cable coming from the radio set can be brought through this grommet hole and connections made to the motor-generator inside of the box. Four screws are shown with this box over which the motor-generator can be slipped and tightened down with washers and nuts. The cable shield can also be grounded to one of these screws. This box, of course, is only a proposed design and whatever motor-generator or "B" voltage supply you might use, the dimensions of the box will have to be changed to suit. In many instances the motor-generator can be placed behind the rear seat or in the tool box, thus eliminating the motor-generator box entirely. The packing strips, parts 9 and 10 (Fig. 14) can be glued to the motor-generator box cover.

Continue this article in the subsequent issue of RADIO-CRAFT, in which the circuit employed in the instrument is given equally detailed consideration. Part 11 also includes a complete List of Parts.

BEGINNER'S SET

(Continued from page 343)

tuning dials track so that the same setting is shown on both for any station. Tune in a high-frequency station tone at about 220 to 250 meters.—Editor. You will find that by varying C5 you can shift the position of best response on the oscillator dial over a very wide range; adjust it until the readings on both dials are the same. Then tune in a station at the other end of the dial and adjust C4 which will also shift the reading.

(Strictly, the inductance of L3 should be considerably less than that of L2 for perfect tracking, but a close enough approach may be had to demonstrate the theory with the two coils available.)

The Mixing Circuit

The general statement of superheterodyne theory given in the beginner's article in the September issue of RADIO-CRAFT, on page 160, sounds and is very simple, but there are many special problems involved in the reduction of this theory to a smoothly operating actual set and one of the chief of these has always been the mixing circuit; or, as it used to be called, the first-detector.

In the earlier superheterodynes it was just that; the incoming R.F. was fed through a regular detector circuit and changed into an audio frequency which was then modulated onto the local-oscillator frequency and changed into intermediate frequency. The coupling between the R.F. and oscillator circuits was either by coils—inductive; or by condensers—capacitive. Both of these methods are open to several objections; first, the coupling varies greatly with the frequency; also, the fact that rather close coupling is required makes the oscillator circuit "pull in" to the frequency of the other circuit rather than operation at its own tuned frequency which, of course, causes the circuit to fail to operate.

Circuits of this type were the best that could be had in those days. When the screen-grid tube came along, the extra grid was immediately put to work to act as a coupling device in place of the coils and condensers. One of the favorite circuits with such tubes was to use the screen-grid as the oscillator plate while the regular plate was used in the normal manner. The only objection to this was that the control-grid had to be used both for an oscillator grid and an R.F. grid which still caused trouble from "pulling in."

The 1A6

The next step was, naturally, to develop a tube designed purposely for such service, and the 1A6 is the answer. A reference to the circuit diagram, Fig. 2A, will show the construction of the tube schematically. There are, as will be seen, a filament, five grids, and a plate. The first grid is the oscillator control-grid, the second grid functions as an oscillator plate. The third and fifth grids are connected together inside the tube and are screen-grids. The fourth grid is the R.F. control-grid for the regular plate. Thus it will be seen that there are two separate grids for the control of R.F. and oscillator and that they are separated electrically by one

section of the screen-grid, which is grounded, as far as R.F. is concerned, through condenser C7.

Therefore, the only connection, electrically, between the oscillator and the R.F. sections is that the electron stream from the filament to the plate must flow through both the R.F. and oscillator control-grids and is therefore controlled (or modulated) by both grids, which causes the mixing action without coupling the circuits so closely that they pull together.

The base connections of this tube are shown in Fig. 2B.

Hints

The circuit is so simple that there is no reason why it should not work "right off the bat." However, the circuit is somewhat more complicated than a straight R.F. job and has a number of adjustments which are dependent one on the other and while a powerful signal will come through in spite of considerable misadjustment, if you live in a neighborhood where powerful stations are scarce it may be a little difficult to get into adjustment, and a number of ways of checking the circuit will be given below.

The first likely point of trouble is the crystal detector which may be on an insensitive spot. Moving the wire about on the face of the crystal will result in scratching and clicking noises in the phones—which had better be used for the original adjustment. The contact between the crystal and the wire must be as light as possible. If it is open, there will be a buzzing noise in the phones.

If you simply can't bring in a signal, it might be well to disconnect the intermediate transformer and put in its place temporarily an untuned R.F. transformer. Short the plates of the oscillator tuning condenser and you will have an ordinary R.F. circuit tuned by C2; which you may use for adjusting the crystal detector.

The oscillator may be checked by attaching a short piece of wire to the point marked "X" on the diagram and connecting the other end of this wire to the antenna post of your broadcast receiver. If the oscillator is functioning, you will hear a whistle in the speaker of the broadcast set when the oscillator is tuned past the station being received.

A milliammeter, if available, may be placed in the "B plus" line leading to the oscillator. If it is functioning, shorting out the plates of the oscillator tuning condenser will cause a change in the reading of this meter.

Parts List

- One 3-circuit tuner for 350 mmf. condenser, L3, L4, L5;
- One 2-circuit tuner for 350 mmf. condenser, L1, L2;
- Two 350 mmf. tuning condensers, C2, C3;
- One 85 mhy. R.F. choke, L8;
- One 175 kc. I.F. transformer, L6, L7;
- Two 250 mmf. mica condensers, C10, C6;
- One 500 mmf. mica condenser, C9;
- One 5 to 50 mmf. mica variable trimming condenser, C5;
- One 200 to 250 mica variable trimming condenser, C4;
- One double .1-mf. paper condenser, 200 V., C7, C8;
- One single .1-mf. paper condenser, 200 V., C11;
- One 25 mf. 25 V. electrolytic condenser, C12;
- One 25,000 ohm, 1/2-watt resistor, R1;
- One 50,000 ohm, 1/2-watt resistor, R2;
- One 150 ohm, 1/2-watt resistor, R3;
- One 500 ohm volume control with switch attached, R4;
- One Rotort crystal detector;
- One type 33 tube, V1;
- One type 1A6 tube, V2;
- One 4-prong wafer socket for power plug;

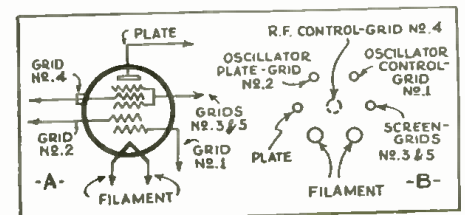

Fig. 2
Details of the type 1A6 tube.

- One 5-prong wafer socket for V1;
- One 6-prong wafer socket for V2;
- One open circuit jack with insulating bushing, J;
- One Ant.-Grd. binding post strip;
- One power plug and 4-wire cable;
- One Rechargeit 2 V. storage cell;
- Three 45 V. "B" batteries;
- Two aluminum panels, 4 x 7 x 1/16-in.;
- Two aluminum sub-panels, 4 x 8 5/8 x 1/16-in.;
- One bakelite detector mounting, 1 1/2 x 3/4 x 1/8-in. or 3/16-in.

SCHOOLBOYS' SET

(Continued from page 343)

Perhaps the first thing to study, if you intend to make this set, is the wiring diagram shown in Fig. 1.

The set's main point is the tube which should be a type 30. This tube draws very little current from the plate battery and only .06-amp. from the 2 V. storage cell.

Tuning is done with a homemade coil, all the dimensions of which are given in Fig. 2. Winding this coil is very easy if you will follow the instructions given in the diagram, anchoring each end of the winding securely and leaving plenty of spare wire for the connections and for the twisted taps. Remember to bare the ends of the tap wires and take care not to cut or break the loops as this would prevent the set from operating.

Concerning the taps; there are two clips making contact with them and you will find that the smallest size "test clips" are fine for this purpose.

What, you may ask, is the object of these coil taps? They play an important part in the set's performance. The upper clip shown in Fig. 1 is used for varying the selectivity of the tuning circuit by varying the extent to which the aerial is coupled to the coil. The lower this clip is placed on the coil, the sharper will become the tuning. However, if this is carried too far, the volume of the music will be reduced.

The Aerial Condenser

You will note, that a further control of the selectivity may be secured by adjusting the semi-variable condenser which is connected between the aerial lead and the clip just mentioned.

Now for the second clip:—You will find this very useful because it enables you to change the amount of wire across the tuning condenser. This will permit you to tune stations either on high wavelengths or below the usual broadcast wavelengths.

Detector Action

The detector tube follows the tuning coil and condenser. This tube converts the oscillating radio waves into "one-way" pulsations which can effect the phones.

We will not bother with this process just now, but remember that in the plate circuit of the tube there is still radio frequency current flowing, and we make use of this to increase the strength of the music. This radio frequency current is passed back from the "plate" to the "grid" of the tube, by a process known as regeneration.

This regeneration is a very important part of the set. Without it, you would not be able

to hear the small stations, so take care to make up the small revolving coil mounted on the rod within the larger coil, very carefully. It is this coil that enables the radio frequency current flowing through it to be fed back into the tuning coil.

The regeneration coil (rotating coil) which is fully illustrated in Fig. 2, is arranged to swing inside the tuning coil, at one end, as shown. The degree of feedback or the regeneration is controlled by the position of this swinging coil. You will soon find the position that gives the maximum effect, for at one point the set will produce a squeal, showing that the tube is oscillating.

This oscillating or squealing point is of no use and the object is to reduce the regeneration by slightly swinging back the coil until the squeal stops. The most sensitive position of the regeneration coil is just beyond the oscillation point.

Having made up the coil, you should study the diagrams shown in Figs. 1 and 3, to see how the parts are fitted into the cigar box. When they have been mounted, you can then undertake the very simple task of wiring the parts together. Tighten the screws very securely after twisting the wire under the screw head, and it is best to mark each wire on the diagram with a colored pencil as soon as it is inserted so that you will be sure to include all the wires.

Operating the Set

When the wires have all been tightly fastened in place, you can connect the batteries. The positive terminals in Fig. 1 marked "plus" are often red, while the negative terminals are sometime indicated with a black color.

The set will work very well on an indoor aerial wire of about 40 ft. but stronger signals will be heard if a longer outdoor aerial is used.

This information is reprinted, with changes to incorporate American parts, from an article in AMATEUR WIRELESS.

STATEMENT OF THE OWNERSHIP, MANAGEMENT, CIRCULATION, ETC., REQUIRED BY THE ACT OF MARCH 3, 1933,

Of Radio-Craft, published monthly at Mt. Morris, Ill., for October 1, 1933.

State of New York } ss.
County of New York }

Before me, a Notary Public in and for the State and county aforesaid, personally appeared Irving S. Manheimer, who, having been duly sworn according to law, deposes and says that he is the business manager of the Radio-Craft and that the following is, to the best of his knowledge and belief, a true statement of the ownership, management (and if a daily paper, the circulation), etc., of the aforesaid publication for the date shown in the above caption, required by the Act of March 3, 1933, embodied in section 537, Postal Laws and Regulations, to wit:

1. That the names and addresses of the publisher, editor, managing editor, and business managers are: Publisher, Continental Publications, Inc., 404 North Wesley Ave., Mt. Morris, Ill.; Editor, Hugo Gernsback, 98 Park Place, New York, N. Y.; Managing Editor, C. Walter Palmer, 98 Park Place, New York, N. Y.; Business Manager, Irving S. Manheimer, 98 Park Place, New York, N. Y.

2. That the owner is: (If owned by a corporation, its name and address must be stated and also immediately thereunder the names and addresses of stockholders owning or holding one per cent or more of total amount of stock. If not owned by a corporation, the names and addresses of the individual owners must be given. If owned by a firm, company, or other unincorporated concern, its name and address, as well as those of each individual member, must be given.) Continental Publications, Inc., 404 North Wesley Ave., Mt. Morris, Ill.; Hugo Gernsback, 98 Park Place, New York, N. Y.; I. S. Manheimer, 98 Park Place, New York, N. Y.

3. That the known bondholders, mortgagees, and other security holders owning or holding 1 per cent or more of total amount of bonds, mortgages, or other securities are: (If there are none, so state.) None.

4. That the two paragraphs next above, giving the names of the owners, stockholders, and security holders, if any, contain not only the list of stockholders and security holders as they appear upon the books of the company but also, in cases where the stockholder or security holder appears upon the books of the company as trustee or in any other fiduciary relation, the name of the person or corporation for whom such trustee is acting, is given; also that the said two paragraphs contain statements embracing affiant's full knowledge and belief as to the circumstances and conditions under which stockholders and security holders who do not appear upon the books of the company as trustees, hold stock and securities in a capacity other than that of a bona fide owner; and this affiant has no reason to believe that any other person, association, or corporation has any interest direct or indirect in the said stock, bonds, or other securities than as so stated by him.

I. S. MANHEIMER,
Business Manager.

Sworn to and subscribed before me this 24th day of October, 1933.

MAURICE COYNE,
Notary Public.

(My commission expires Mar. 30, 1934.)

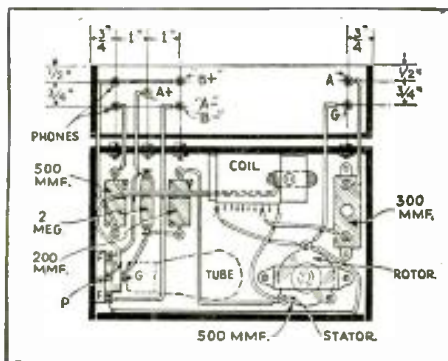

Fig. 3

A suggested arrangement of the parts.

Announcing
THE
TRIPLIET
PERPETUAL
TESTER No. 1177

THIS finer tester is built for a lifetime of service. It has every feature you need to diagnose and remedy set troubles. Test tubes while operating in the set socket. Tests set circuits and aligns tuning condensers. Fulfills every testing requirement in the home or in the shop. Contains a direct reading Ohmmeter, Output meter, A.C.-D.C. Voltmeter and Milliammeter. Meter is 3 1/2" in size.

Precision Built

The single meter, when used as either an A.C. or D.C. Voltmeter has 1000 ohms resistance per volt. Voltage readings are 15-150-750. The D.C. milliamperere readings are 1.5-15-150. The A.C. milliamperere readings are 15-150. The direct reading Ohmmeter, with the easy reading scale, has red and black figures which make possible accurate readings from 3 megohms down to 1 ohm. All readings are controlled by a selector switch. Point to point continuity tests are made with this part of the instrument. The meter is also used for indicating output when set is connected with the oscillator for aligning condensers and measuring gain in tube values.

A switch on the oscillator permits its use for generating either a stabilized modulated or unmodulated signal of constant level. Extremely accurate scale divisions cover fractional frequencies on the individually hand made chart from 110 to 1600 KC.

Your Jobber Can Supply You
Net price to dealer in oak case \$26.67



Send Coupon for Facts!

Triplet Electrical Instrument Co.
21 Main St.,
Bluffton, Ohio

Gentlemen:

Send me literature on Triplet No. 1177 Perpetual Tester.

Name _____

Street Address _____

City _____

State _____



Midget Electrolytic Replacements



FOR POPULAR AC-DC
MIDGETS
CROSLY
INTERNATIONAL
CADET
GENERAL ELECTRIC
and many others

Same sizes as original units
Famous Tobe quality

Write for catalog E-1233 listing the
complete line of Tobe replacement
condensers.

**TOBE DEUTSCHMANN
CORPORATION**
Condenser Division
CANTON MASSACHUSETTS



Announcing
The New 1934
Improved
Prizewinner
A.C.-D.C. S. W.
Receiver

Complete with four coils
\$12.95
Verified Worldwide Reception
Completely Self Powered Latest Type 71-43 and
25Z5 Tubes—15-200 meters.
Provision for Headphones and Speaker
Complete Kit of Improved Prize winner parts, identical
with those used in built-up models, including
battery re. hookup, wire cabinet, dial, 4 coils...\$10.55
Assembled, wired, tested and enclosed in beautiful,
crackle finish cabinet, hinged cover ready to plug
into your line.....\$12.95
Kit of RCA or Arcturus tubes to match..... 3.75
Broadcast coil for covering from 200 to 500 mtrs. 0.90
220 V. A.C. or D.C. Adapter..... 1.75
Send for full particulars
ALAN RADIO CORP.
83R CORTLANDT STREET NEW YORK CITY

HIGH-FREQUENCY LOUD SPEAKER



Efficient, precision-built dynamic
unit to cover audio band from
200 to 12,000 cycles. Specially
designed horn included with unit.
Perfect for wide-range reproduction.
Can be used with large horn
or cone speakers and filter listed
below.

List \$25.00

Special high and low-
bass filter with coup-
ling transformer, for
amplifier output. Cast
aluminum case and
coupling transformer.

List \$25.00

Write Dept.
RC-12 for Data

RACON ELECTRIC CO., Inc.
52 East 19th Street, New York, N. Y.

A 5-UNIT TESTER

(Continued from page 337)

The chart in Fig. 1, shows at a glance the interconnected functions of this radio tester. A D'Arsonval type meter serves as the "heart" of the entire device.

The free reference point system in itself constitutes a most valuable forward step in test instrument design. The fundamental principle involved in this system is the connection of each element of the tube to the contact arm of an individual selector switch, so that each element of the tube can be placed in its proper connection in the circuit. An individual socket is provided for the four, five, six and seven prong tubes. The socket holes are numbered in accordance with R.M.A. standard designations. All four sockets have their corresponding numbered contacts wired together and brought out to convenient terminals to which any ranges of the meter may be applied for any desired measurements.

The large multi-point rotary switch connects the A.C. tube tester circuits to the four molded sockets for tests of all types of tubes without exception, so that tubes may be tested either from radio tube sockets or with a separate A.C. power supply. Referring to Fig. 2A, it will be seen that each grid and plate connection is made through an opening (push button) switch between a pair of pin jacks, so that any range of the meter may be connected for tube test measurements in any of the tube test circuits and the currents of both plates of full wave rectifiers and duo-diode tubes may be measured. An automatic short test saves time, and protection is given to the meter by means of a heavy duty resistor in the plate circuit. A gas test is provided by inserting a high resistance in the circuit so that the gas current will cause a change in the grid voltage, readily observable on the plate milliammeter. Some of the later tubes incorporate the functions of two or

more tubes in a single envelope. Individual tests of each combination of elements can be made. In the case of the duo-diode tubes, such as the 55, a low voltage can be applied to each diode in turn, and the resulting current can be compared with the minimum values set by the tube manufacturers on these particular tubes.

A simplified schematic of the analyzer circuit appears in Fig. 2A. The push-button switches between the pin jacks are normally closed. The 0.6-mf. condenser serves the purpose of stabilizing the high-gain stages during analysis. All circuits of the radio tube sockets are extended through the analyzer cable to the four molded sockets and to convenient terminals to which any range of the meter may be applied for current, potential and resistance measurements.

The single .001-amp. 300 ohm, D.C. meter, used to interpret all analytical potentials and currents, is shown schematically in Fig. 2B. The specific meter functions desired are selected by a positive action, four-point rotary switch the arms of which connect to the meter. The 18 potential and current measuring ranges include six ranges for the measurement of D.C. potentials, 0—5; 25; 125; 250; 500; 1,250; six ranges for the measurement of D.C. milliamperes, 1—5; 25; 125; 250; 500; 1,250; and six ranges for the measurement of A.C. potentials, 0—5; 25; 125; 250; 500; 1,250. All meter ranges terminate at pin jacks on the tester panel. They are interpreted on a single evenly divided arc on the meter.

As shown in Fig. 2C, the use of a single D'Arsonval meter scale is made possible by a newly developed A.C. voltmeter circuit. In this circuit a full-wave instrument rectifier is used in conjunction with the one ma. movement of the D.C. meter to form a sensitive A.C. milliammeter, but a departure is made from the older circuits in the use of capacitor reactance in addition to the usual

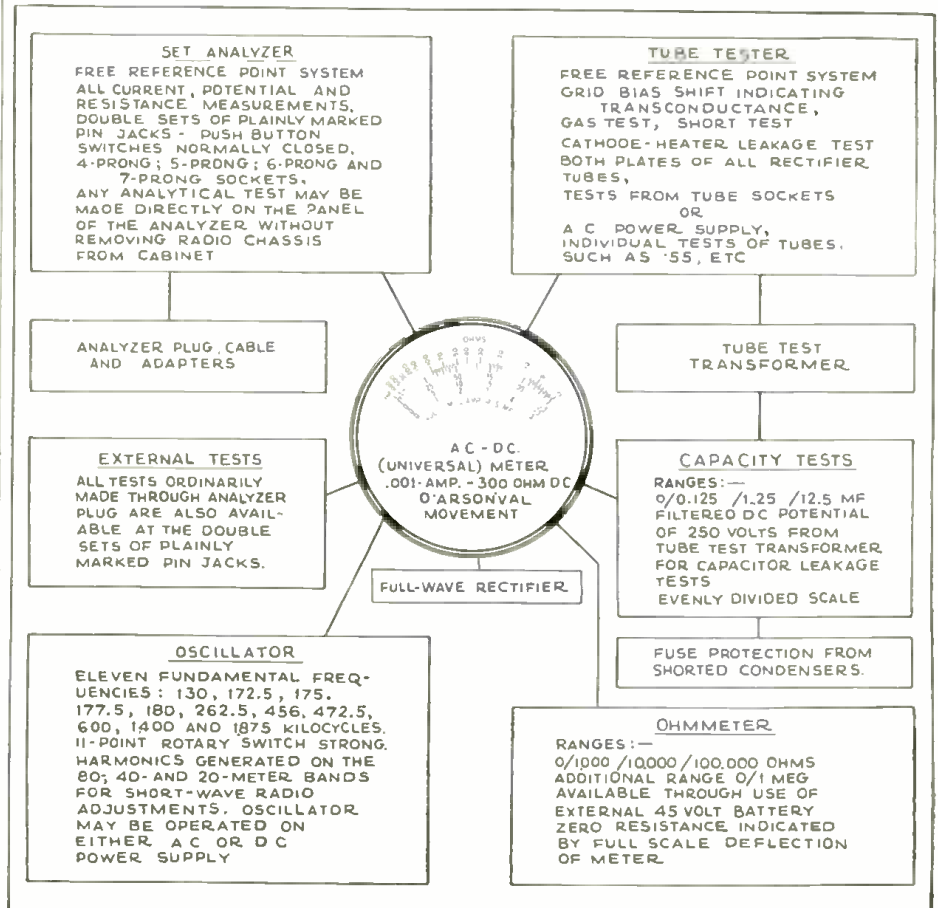

Fig. 1

The versatility of the 5-unit tester is indicated in the above chart.

multipliers for range separation. Referring to the diagram, this shows the meter, an A.C.-D.C. changeover switch, included as a part of the four-position rotary switch, and two voltage ranges. Point 12 is common for both A.C. and D.C. Point 18 is the first range and point 1 is the second range. To read a D.C. potential of a value less than full scale on the first range, contacts 12 and 18 would be used and the switch would be thrown to the right. The D.C. potential, being blocked out of the rectifier by capacitor 17 would pass through the multiplier 3 and through the meter. Similarly, a D.C. potential on the second range would, since it could not pass capacitors 19 and 17, be forced to take the path through multipliers 2 and 3 and so on through the meter. Thus, for D.C. measurements, the meter functions as a nominal 1000 ohms-per-volt instrument and any A.C. potential applied to it would produce no meter reading. To read an A.C. potential, the switch 5, is thrown to the left; an applied A.C. potential would then cause a current to pass through capacitor 17 and to be rectified by the full-wave rectifier, 13, 20, 16, 21, before entering the meter. The value of the capacitor 17 is so chosen that its reactance at the frequency for which the instrument is calibrated, combined with the resistance of the rectifier unit itself, constitutes the multiplier for the first range and since the two are combined vectorially, the total impedance of the circuit is made up almost entirely by the capacitor reactance. Hence the unavoidable changes in rectifier resistance with varying magnitudes of current, become negligible in the calculation of the total impedance and an evenly divided meter scale is made possible.

Figure 2D shows the entire A.C.-D.C. volt-meter and capacity meter circuits of the tester. The D.C. network is in heavy lines and the A.C. network of which the capacity meter is a part, is shown in dotted lines. Due to the even scale distribution of the new A.C. circuit used, the capacity meter reduces to a simple A.C. milliammeter shunt, which is thrown across the meter when the capacity switch is closed.

Three ranges are provided by the ohmmeter, shown in Fig. 2E, 0-1,000; 10,000; 100,000 ohms. The additional range 0-1 meg. is obtained by using an external 45-V. battery. The circuit shown is accurate and simple. It is a combination of shunt and series resistors with the unknown resistor inserted in series with the network.

A COMPACT P.A. SYSTEM

(Continued from page 349)

greater power output than with similar tubes of 6.3 V. filament design. The use of only one audio driver transformer and two resistance coupled A.P. stages assures maximum fidelity that compares favorably with class A reproduction. The filter system (composed of two chokes Ch 1, Ch 2 and a 24 mf. electrolytic condenser block C7, C8 and C9) is built upon the amplifier chassis proper for the reason that it is useful, regardless of what type of power supply is employed. The plate and filament connections are brought out to a recessed 5 prong male plug P1. Note that all filament connections should be made with No. 12 wire, to avoid excessive voltage drop.

110 V. A.C. Power Supply

The power transformer PT, possesses true class B voltage regulation and has the following specifications: 350 V. A.C., 110 mits.; 2.5 V. A.C., 3 amps.; 6.3 V. A.C., 3 Amps.

A conventional class B choke Ch 3 (200 ohms) is used in addition to the other two chokes (Ch 1 and Ch 2 within the amplifier chassis proper) to absolutely eliminate all traces of A.C. ripple. The rectified output and filament supply are brought out to a 5 prong female socket PS 2, shown in Fig. 2A.

The Motor-Generator

No filter system is required with this generator as long as no radio tuner is used in conjunction with this amplifier system. It is important to employ at least No. 12 gauge conductors between the storage battery and

PORTABLE PUBLIC ADDRESS EQUIPMENTS!

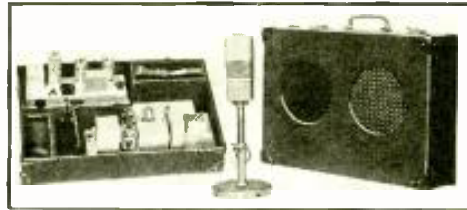

TYPE PG-62—A complete Portable Public Address System, including the famous VELOCITY MICROPHONE, a high grade Class B 20 watt amplifier, and two modern dynamic loudspeakers—all self-contained in one convenient carrying case. Operates on 110 volt AC and is designed to faithfully reinforce speech and music. Has provision for electric phonograph input.

TYPE PG-63—A smaller and lighter design including close talking carbon microphone, Class B 6 watt amplifier and dynamic loudspeaker—all self-contained in one convenient carrying case. Operates on 110 volt AC and is designed to reinforce speech and music, and has provision for electric phonograph input.

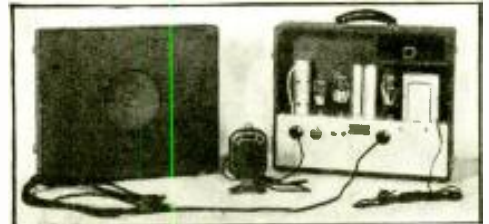

A full line of high quality sound reinforcing equipment is available for permanent installations.

Surveys and estimates furnished on request and without obligation.



Write for descriptive literature.
ANYTHING IN SOUND REPRODUCTION
Photophone Division

RCA VICTOR COMPANY INC.
"Radio Headquarters" CAMDEN, N. J.

HEADQUARTERS FOR PUBLIC ADDRESS AMPLIFIERS

BUY DIRECT from MANUFACTURER and SAVE BIG MONEY!

Portable—Completely Self Contained—10 Watt 4 Stage P.A. Amplifier System
Operates from choice of 6 Volt storage battery or from 110 Volt A. C. or from both.

Housed within two cases which "INTERLOCK" or NEST, one upon the other, forming an easily transported and unified system. Includes a 4 Stage Class "B" 10 Watt Amplifier, 6 Volt Motor Generator, 110 Volt A.C. Power Pack, 6 Volt Phono Motor with 110 Volt A.C. Adaptation, 6 Volt "P.A. Auditorium" Wright De Coster Dynamic Speaker with 110 Volt A.C. Field Exciter, Removable "IMPULSIVE MIXER-FADER" Control Box, Phono-Pickup, Double Button "Mike" and stand.
Write for Attractive Low Prices and Further Details.

Here is **BIG VALUE** Victor Push-Pull 245 Amplifier

Excellent For All Microphone, Phono-Pickup And Radio Tuner Amplification Applications.

Instantaneous Heater Amplifier (ideal for "Call Systems") employs 1-226, 2-245, 1-250. Standard Model uses 1-56, 2-245, 1-290. Equipped with an output push-pull transformer for 7.15 ohm voice coils, and a phonograph transformer, etc. Features D.C. Field current to a 2500 ohm 110 Volt D.C. Dynamic Speaker. High gain characteristics, and use of two A. F. stages, assure clear tone volume on "mike" and phono pickup. Completely assembled kit, anybody can wire this amplifier easily... wiring diagrams furnished. 110 volt A.C., 60 cycle.

\$6.95 LESS TUBES & SPEAKER
SET OF 4 TUBES \$1.69
MATCHED DYNAMIC SPEAKER \$1.95

COAST-TO-COAST-RADIO-CORP.
123 K. WEST 17TH STREET, NEW YORK, N.Y.

CONCOURSE CONDENSERS

highest quality for lowest cost

Every Type of Dry Electrolytic and Wax Paper Condenser
All Capacities and Voltages

To fill every Serviceman's requirements

Send in your request for our complete descriptive catalogue

CONCOURSE CONDENSERS

389-409 Wales Ave. N. Y. City

Try this FORMULA

WHEN you design or build that new Set Analyzer, Decade Box, Bridge, Ohmmeter or High Resistance Voltmeter why not try this FORMULA:

$$Q + A + MD = PwWR$$

LC
When Q equals QUALITY and A equals ACCURACY MD equals MODERN DESIGN and LC equals LOW COST and LAST COST then PwWR is always PRECISION WIRE WOUND RESISTORS.

RESISTANCE RANGE: .25 Ohm to 1 Megohm

TYPE "F"
Normal Rating 1 Watt
Maximum Length 1"
Maximum Diameter 1/4"
Length of Lead 1 1/2"
Furnished with No. 18 Tinned Copper Leads.



TYPE "D"
Normal Rating 1/2 Watt
Maximum Length 3/4"
Maximum Diameter 1/8"
Length of Lead 1 1/2"
Furnished with No. 18 Tinned Copper Leads.

Free Booklets and Price List
Precision Custom Built Wire Wound Resistors, Mfg. by
PRECISION RESISTOR CO.
334 Badger Ave. Newark, N. J.

STEWART-WARNER FACTORY CO-OPERATION FOR SERVICE MEN

Service meetings will be held all over the country by special factory radio field engineers. Complete diagram talk on new as well as old Stewart-Warner circuits will show you the easy way to service Stewart Warner radio sets. Service manuals on all new Home and Auto Sets will be given free.

For time and place of meeting, write

Service Department

STEWART-WARNER CORP.
1826 Diversey Parkway - - Chicago

DIAMOND TUBES at BARGAIN PRICES

All tubes are R. C. A. Licensed and are Guaranteed for 90 days. Dealers and service men let us show you how you can increase your profits on tube sales. Our tubes will improve the quality and tone of any set.

| Type | Price | Type | Price | Type | Price | Type | Price |
|------|-------|------|-------|------|-------|------|-------|
| 201A | .25 | 234 | .65 | 58 | .45 | 125M | .85 |
| 226 | .27 | 236 | .50 | 59 | .55 | 401 | 1.10 |
| 227 | .27 | 237 | .40 | 75 | .65 | 403 | 1.25 |
| 245 | .28 | 238 | .45 | 77 | .60 | 485 | .50 |
| 171A | .28 | 239 | .50 | 78 | .60 | 182 | .55 |
| 240 | .28 | 41 | .50 | 79 | .75 | 183 | .65 |
| 211A | .45 | 42 | .50 | 281 | 1.10 | 210 | 1.25 |
| 235 | .45 | 43 | .75 | 82 | 4.00 | 259 | 1.10 |
| 251 | .45 | 44 | .50 | 83 | .45 | 247 | .75 |
| 247 | .45 | 46 | .50 | 84 | .65 | 217 | .85 |
| 112A | .40 | 48 | 1.75 | 85 | .50 | 647 | .75 |
| 230 | .50 | 49 | .65 | 89 | .55 | 6B7 | .85 |
| 231 | .50 | 55 | .50 | X99 | .45 | 25Z5 | .65 |
| 232 | .55 | 56 | .35 | V99 | .40 | 250 | 1.10 |
| 233 | .65 | 57 | .45 | 222 | .85 | 2A5 | .65 |

No order accepted for less than \$3.00. Order from this ad. All prices F. O. B. factory. 20% deposit with all orders.

Radio Tube Exchange of America
60 Washington St. New York, N. Y.

POSTAL "INTERNATIONAL"



A communication type 9 tube professional receiver especially designed for the amateur and short wave fan. T. R. F. pre-selector stage, instantaneous band spread with new draw coils, heterodyne oscillator for c.w. reception, automatic phone jack and electron coupled oscillator. Image frequencies (repeated spots) eliminated, unusual sensitivity and selectivity from 1500 to 20,000 k.c. For those Hams and advanced short wave enthusiasts who prefer the best in short wave.

1500 20,000 k.c. For those Hams and advanced short wave enthusiasts who prefer the best in short wave.
POSTAL RADIO CORP. 135K Liberty St. N. Y.
Please send me FREE diagram, special offer and circular on the INTERNATIONAL PROFESSIONAL.

NAME.....

ADDRESS.....

CITY.....

STATE.....



MAKE A LOUD SPEAKER SYSTEM

out of any Radio Set having a phonograph connection—MODEL QXF consists of microphone, transformer, volume control and battery receptacle—all compactly assembled in a box with 15 ft. of cord for connecting. Not a noisy toy, but a real microphone and transformer combination that gives real results. Now reduced to \$7.50 list.



(Standard)

UNIVERSAL Microphone Co., Ltd.
424 Warren Lane, Inglewood, Calif., U. S. A.

SEND FOR FREE RADIO ACCESSORY CATALOG

1933 PUBLISHED BY UNIVERSAL MICROPHONE CO. 424 WARREN LANE, INGLEWOOD, CALIF., U.S.A.

CONTAINS 100 MORE 1000 LISTINGS 1000 NEW ILLUSTRATIONS - VALUABLE DIAGRAMS - MAKE UP YOUR OWN CIRCUITS FOR PUBLIC ADDRESS AMPLIFIERS AND EQUIPMENT

NRA

COAST TO COAST RADIO CORPORATION
1218 WEST 17th STREET - NEW YORK, N. Y.

EX-STAT
REG. U. S. PAT. OFF.

SERVICE MEN: New! EX-STAT 20-watt wire-wound resistors. Same size as ordinary 3-watt resistors. Post card to-day brings bulletin.

Tilton Manufacturing Co.
17 East 26th Street, New York

avoid harmful voltage drop. The high voltage line is fused by employing a 6 V. mazda pilot lamp. The 6 V. input and output connections are brought out to a 5 prong female socket PS 3 (Fig. 2B).

Phono. Motor Assembly

The phono motor unit consists of a single or dual speed (33-1/3 and 78 R.P.M.) phono motor that draws only 1 1/4 amps! It is governor controlled for speed regulation. A single-pole double-throw switch Sw2 (Fig. 2C) is employed to provide optional operation of the phono motor from either the 6 V. storage battery or from the phono motor A.C. power supply unit.

An A.C. step-down transformer PT2, shown in Fig. 2C, supplies 13 V. A.C. at 3 amps, to a copper oxide rectifier, COR1, which produces 6 V. A.C., at loads up to 2 1/2 amps. A dummy load resistor (R12), 7 1/2 ohms, 6 W. in conjunction with a 1500 mf., 15 V. electrolytic condenser, C10, maintains a constant voltage output, and accordingly insures constant speed of the phono motor, regardless of power line voltage fluctuations. The output (PS3) of this device is connected to the phono motor proper through switch Sw2 which is located on the phono motor mounting board (Fig. B). Another switch Sw1, also located on this board, is used to completely disconnect this phono motor supply device from the 110 V. A.C. power line.

Dynamic Speaker Exciter

The dynamic speaker field supply unit shown in Fig. 2D is only employed when it is desired to operate the 6 V. D.C. dynamic speaker from 110 V. A.C. Lines. It is identical to the phono motor current supply, differing only in that the rectified output is brought out to a female outlet PS6. The dynamic speaker field is connected to a conventional male plug, which in turn is plugged into this socket (PS6) whenever 110 V. A.C. operation is desired.

The Input "Mixer-Fader" Control Box

For satisfactory performance, a phono or "mike" input transformer should never be contained within an amplifier, to avoid induced hum or ripple pickup. For this all-important reason, the input transformers and their respective controls are housed in an external metal case. This completely shielded unit can be operated at a distance from the amplifier, and can be removed from the speaker case in a "jiffy" by virtue of a bracket arrangement. This device was completely described in the November issue of RADIO-CRAFT on page 282, to which you are referred. Briefly, it makes possible the mixing, blending, super-imposition and fading (as well as individual volume and tone control, of any one of the following three input signals: phono pickup; microphone; radio tuner. It enables you to make speeches and at the same time have a back ground of music being produced from records. All the connections to this device are conveniently and quickly made on the rear panel.

Convenient Connection Socket Arrangement

It will be observed that all the necessary connections to power supply units are made to the male and female plugs and sockets, conveniently located on one of the amplifier section sides. A short connection plug CP, (Fig. C) having a 5 prong female socket at the other, enables you to adapt this amplifier to either 6 V. D.C., or 110 V. A.C. operation. For 6 V. operation, the female end of this CP plug is inserted into P 1 (Fig. A), and the other end (male plug) is inserted into PS 3.

For 110 V. A.C. use, this male plug is removed from PS 3 and inserted instead into PS 2. . . *that is all there is to it!* Plug PS 4 is a recessed male plug (polarized) and is used for the connection of the 6 V. supply brought to the unit by a female polarized plug. Male plug PS 5 is also recessed (non-polarized) and provides 110 V. A.C. power line distribution. The female socket PS 7 is connected by a shielded conductor to BP 1 (grid) and BP 2 (ground) input of the amplifier proper—it is into this socket (PS 7) that the output of the remote control input mixer box is plugged. Into PS 8 female socket, there is inserted a male plug which

carries the phono pickup leads to the input mixer control box—obviously the phono pickup should be connected to this socket (PS 8). The three remaining female sockets on the bottom, PS 1, PS 2, PS 3, are for the speaker connections (voice coil or monitor leads). It is impossible to plug the wrong plug into any terminal other than the one for which it is intended—making this system fool-proof, in the hands of any non-skilled operator!

Complete kits or factory wired models of this highly efficient P.A. System are obtainable. The author will be pleased to answer all inquiries relative to this system.

LIST OF PARTS

Amplifier

One Coast-to-Coast chassis, drilled 12 x 4 1/4 x 2 3/4 ins. high;
One Remington class B input transformer, T1;
One Remington class B output transformer, T2;
One Lynch 1/2-meg. metallized 1 W. resistor, R1;
One Lynch 5,000 ohm metallized 1 W. resistor, R2;
Two Lynch .1-meg. metallized 1 W. resistors, R3, R7;
One Lynch 25,000 ohm metallized 1 W. resistor, R4;
Three Lynch 3/4-meg. metallized 1 W. resistors, R5, R8, R10;
One Lynch 10,000 ohm metallized 1 W. resistor, R6;
One Lynch 1,000 ohm metallized 1 W. resistor, R9;
One Lynch 0.5 ohm wire wound 5 W. resistor, R10;
Two 5 mf. 35 V. electrolytic condensers, C1, C5;
One 2 mf. 500 V. electrolytic condenser, C2;
Two .02 mf. 300 V. tubular paper condensers, C3, C4;
One 10 mf. 75 V. electrolytic condenser, C6;
One triple 8 mf. 500 V. electrolytic condenser, C7, C8, C9;
One Aerovox .006 mf. mica condenser, C10;
Two Remington filter chokes (500 ohm, 15 hy., 35 ma., Ch1, Ch2);

Power Pack

One Remington power transformer (350-350 V., 80 ma., for class B regulation; 2 1/2 V., 3 amps C. T.; 6.3 V., 3 amps.), PT1;
One Remington filter choke (15 hy., 200 ohms, 80 ma., Ch3);
One 1 amp. fuse;
One Lynch 1/4 meg. metallized 1 W. resistor, R11;
One Coast-to-Coast chassis, drilled, 4 1/4 x 12 x 2 3/4 ins. high,

Speaker Exciter

One Remington power transformer (13 V., 3 amps.), PT3;
One 1500 mf. electrolytic condenser, 15 V., C11;
One 7 1/2 ohm 6 W. wire-wound resistor, R13;
One 2 1/2 amp. copper oxide rectifier, COR2;
One Coast-to-Coast drilled chassis 6 1/4 x 4 1/2 x 2 3/4 ins. high;
One assortment of necessary hardware;

Phono. Motor Current Supply

One Remington power transformer (13 V., 3 amps.), PT2;
One 1500 mf. electrolytic condenser, 15 V., C10;
One 7 1/2 ohm 6 W. wire-wound resistor, R12;
One 2 1/2 amp. copper oxide rectifier, COR1;
One assortment of necessary hardware;

Additional Equipment

One Coast-to-Coast 6 V. D.C. generator;
One Coast-to-Coast 6 V. phono motor;
One 12 in. diameter 6 V. dynamic speaker;
One dual speed phono pickup;
One Coast-to-Coast double button microphone and stand;
One Coast-to-Coast input "Mixer-Fader" control box;
Two Coast-to-Coast special portable interlocking carrying cases;
Two R.C.A. 56 tubes;
One R.C.A. 89 tube;
One R.C.A. 53 tube;
One R.C.A. 82 tube;
One assortment of extension cables, connecting plugs and hardware.

A VELOCITY "MIKE"

(Continued from page 329)

which is amplified by the pre-amplifier to such an extent that it can be used to furnish the input to any standard power amplifier.

Due to its inherently simplicity, a velocity microphone may be constructed quite readily by the amateur or home set builder, provided suitable material is at hand.

A velocity microphone kit has been made available for this purpose, which can be assembled by a novice in less than an hour. This kit is illustrated in Fig. A. It consists essentially of two permanent magnets, two magnet retainers, two "T" pole pieces, two bakelite yokes, a corrugated aluminum alloy ribbon having a thickness of .00065-in. and a width of 3/16-in., two ribbon clamps, fastening screws, soldering lugs and other hardware.

Figure 1A and B shows a front view and a sectional side view of the various parts after they have been assembled. An enlarged view of the ribbon assembly is shown in Fig. 1C.

The method of assembling this microphone is perfectly straightforward. The first step is to slide the two permanent magnets into the magnet retainers, taking care to match their poles, N to N and S to S. The magnets should be separated just far enough to allow the 10-32 screws to pass between them.

One of the two "T" pole pieces is then placed within this assembly and is fastened to one side of the magnets with two 10-32 screws. The other "T" pole piece is placed on the other side and fastened with the other two 10-32 screws. The four screws should not be tightened before making sure that the two magnets are as close together as the thickness of the 10-32 screws will allow.

The next step is to place one of the bakelite yokes, with the bevelled edge down across one end of the "T" pole pieces, fastening it with two of the 4-36 screws. The other bakelite yoke is similarly fastened at the other end of the "T" pole pieces.

The four 10-32 screws are then loosened and the two permanent magnets are removed by sliding them out, first however, making a pencil mark on them, so that they can be replaced in exactly the same position. This operation is recommended because it makes the assembly of the ribbon much easier. However, those who are especially deft with their fingers, can proceed without removing the magnets.

The utmost care should be exercised in handling the corrugated ribbon. This is the heart of the microphone and once it is stretched beyond its elastic limit it becomes worthless. The ribbon must first of all be removed from its cardboard holder and its ends straightened out. Then the "T" pole piece assembly is turned over so that the bakelite yokes are underneath (facing the work bench). One of the holes of the ribbon should then be placed very gently over the center hole of one of the bakelite yokes. The point of a pencil should be inserted through it and the unused end of the ribbon should be tucked under. The pencil is removed and the ribbon centered within the pole pieces by sliding it to the right or to the left. One of the ribbon clamps is then placed over the end of the ribbon as shown in the side view of Fig. 1. This is fastened to the bakelite yoke with one short 4-36 screw.

The loose end of the ribbon should then be grasped and pulled *very carefully* until the hole exactly corresponds with the threaded hole in the center of the bakelite yoke. *Un-*

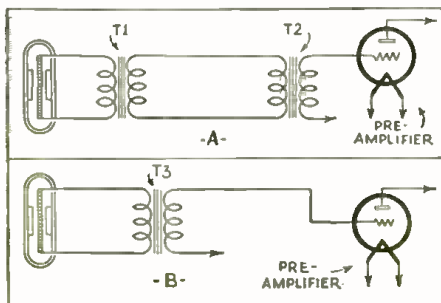

Fig. 2

Connections of the mike to the pre-amplifier.

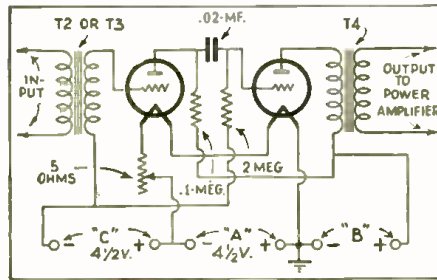

Fig. 3

A pre-amplifier for the ribbon mike.

der no circumstances should the ribbon be stretched beyond this point.

Once again, the point of a pencil is inserted through the ribbon hole into the bakelite yoke, the unused portion of the ribbon being tucked under. In order to make sure that the ribbon is in the center of the space between the two "T" pole pieces, it is necessary to look through the assembly at a source of light or at a piece of white paper. The light should pass between the ribbon edges and to the pole pieces. When properly handled, the ribbon should be parallel with the edges of the pole pieces. Once the ribbon is centralized, the second ribbon clamp should be put in place and secured the same way as the first one.

The assembly is now turned over and a soldering lug is inserted over each of the two short screws which were placed in the bakelite yoke. These are secured with "acorn" nuts. The two permanent magnets are replaced in their original positions (N to N and S to S) and re-fastened to the two magnet retainers. This completes the assembly and the velocity microphone is now ready for testing. The test for a short circuit is made between one soldering lug and a pole piece, using 110 V. with a lamp in series to burn out any high resistance short. If the test shows clear, the microphone is ready for use. If not, the short circuit must be located and cleared.

Figure 2A shows the method of connecting the ribbon microphone to a pre-amplifier located several hundred feet away, and constructed as an integral part of the power amplifier. Two coupling transformers are necessary. When the pre-amplifier is close to the microphone, the method shown in Fig. 2B is employed. It will be noted that a different type of coupling transformer must be used.

Figure 3 shows the schematic diagram of a two-stage pre-amplifier suitable for use with the ribbon microphone. Either 30 type or 864 type tubes may be used.

The curves in Fig. 4 show the output level and frequency response of the velocity microphone in comparison with three other types. It can readily be seen that the velocity microphone has a far better frequency response than any of the other types. The frequency response of the velocity microphone is devoid of resonance peaks and its curve is remarkably flat up to 12,000 cycles per second. Thereafter it curves very gradually until it

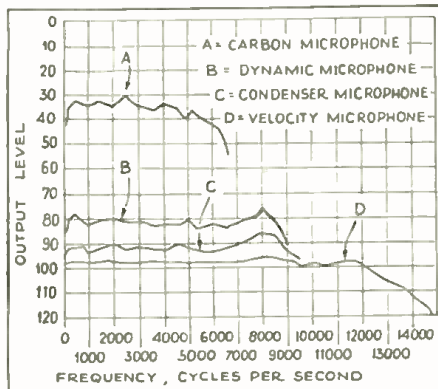

Fig. 4

The superior curve, D, of the ribbon mike.

- building, testing and repairing all kinds of radio receivers!



THE three volumes of this library cover the entire field of building, repairing and "trouble-shooting" on modern radio receivers. The Library is up-to-the-minute in every respect and is based on the very latest developments in the design and manufacture of equipment. The rapidly-growing interest in short-wave and television reception is thoroughly covered in a complete section which deals with the construction of this type of apparatus.

Radio Construction Library

INCLUDING SHORT-WAVE AND TELEVISION RECEIVERS AND AUTO RADIO

By JAMES A. MOYER and JOHN F. WOSTREL

Faculty, University Extension, Massachusetts Department of Education

Three Volumes—1087 Pages, 6 x 9 605 Illustrations

VOLUME I: presents the fundamental principles of radio so clearly and simply that anyone of average training will be able to read, understand and apply them. It gives actual working drawings and lists of materials for the construction of many typical sets.

VOLUME II: Newly revised edition, fully discusses all of the elementary principles of radio construction and repair. An explanation of the necessary steps for "trouble-shooting," repairing, servicing and constructing radio sets successfully. Practical data is also given on auto radio, midget sets, radio-voice meters, automatic volume, tone and static control, etc. This volume includes complete instructions for the construction and operation of short-wave and television receivers.

VOLUME III: covers the essential principles underlying the operation of vacuum tubes in as non-technical a manner as is consistent with accuracy. It discusses the construction, action, reactivation, testing and use of vacuum tubes; and an interesting section is devoted to remote control of industrial processes; and precision measurements.

EXAMINE these books for 10 days FREE

This Library is not only a thorough home-study course, but a handy means of reference for the more experienced radio experimenter, repair man, and radio shop-owner. To these men, as well as to those who desire to advance in the radio profession, this offer of a 10 days' Free Examination is made.

Simply clip, fill in, and mail this coupon

McGraw-Hill
FREE EXAMINATION COUPON

McGraw-Hill Book Company, Inc.,
330 W. 42nd St., New York.

Gentlemen:—Send me the new RADIO CONSTRUCTION LIBRARY, all charges prepaid, for 10 days' Free Examination. If satisfactory I will send \$1.50 in 10 days, and \$1.00 a month until \$7.50 has been paid. If not wanted I will return the books.

Name

Home Address

City and State

Position

Name of Company.....RC-12-33
(WRITE PLAINLY AND FILL IN ALL LINES)

• APPLY

—the technical data in the new Hammarlund Catalog "34" and improve your radio construction work.
For FREE COPY, write Dept. RC-12. Ask also for information on COMET "PRO"—the world's most efficient short-wave superheterodyne.

HAMMARLUND MFG. CO.
424 W. 33rd Street
New York, N. Y.

For Better Radio
Hammarlund
PRECISION
PRODUCTS

Transformers
REWOUND AND REBUILT

Embenton's 17 year record in manufacturing, rewinding and rebuilding transformers assures performance in many ways, even far superior than the original. Each completed job is an achievement of perfection in workmanship, materials and electrical characteristics. Our specialties are rewinding transformer with 12 gauge. Write for free, interesting brochure, "Transformer and Transformer Rebuilding Service." Address, Dept. RC, PEMBERLETON LABORATORIES, 921 Parkview Avenue, Fort Wayne, Indiana.

WHITE FOR NEW CATALOG

Sensitivity & Tone Quality
SHURE MICROPHONES

SHURE BROTHERS COMPANY
Manufacturers of MICROPHONES
215 WEST HURON ST. CHICAGO, ILLINOIS

JOHNSON RADIO NEWS
will be sent free to anyone who will state where he has seen this advertisement.

JOHNSON RADIO MFG. CO.
507 Tarrytown Rd. Pleasantville, N. Y.

MAKE BIG PROFITS **ONSOUND EQUIPMENT**
Buy from the World's Largest Suppliers

Exceptional Bargains in New, Used, and Rebuilt Motion Picture Apparatus. Recent Government Surplus and Liquidation of other manufacturers such as FACENT, POWERS, CINEPHONE, BIOPHONE, RCA PHOTOPHONE, and others now offered to our trade.

S. O. S. CORPORATION
Dept. RAC, 1600 Broadway, New York, U. S. A.
EXPORT: 120 Liberty St., New York
Cable Address: "SOSOUND" New York. All Codes.

SERVICEMEN!
THE MOST COMPLETE LINE OF CONDENSERS AND RESISTORS FOR EVERY RADIO USE
Write for our new 8-page Catalog folder free of charge

AEROVOX CORPORATION
76 Washington Street Brooklyn, N. Y.

AUTOCRAT'S 1934 QUALITY RADIOS
AT REASONABLE PRICES

Model 90SL, New All-Wave Super 15-540 METERS. No coils to change. For distant stations come in with tremendous volume and ease. Other 1-5-6 Tube Quality Radios.
Write for Circular and Dealers Prices

AUTOCRAT RADIO CO.
3855 N. Hamilton Ave. Chicago, Ill.

GET THE BIG RADIO CATALOG

THE RADIO SUPPLY WORLD IN 148 BIG PAGES
Just out for 1934. Make your request for it on your Dealer's, Service Man's, School's, Experimenter's or Amateur's letterheads. Order from America's Largest Radio House in America's Handicapped Shipping Point.

BURSTEIN-APPLEBEE CO.
Dept. A-2 1012 McGee St. KANSAS CITY, MO.

reaches its upper frequency limit. Incidentally, the velocity microphone has a frequency range from 30 to 16,000 cycles per second—an obvious impossibility in any microphone depending upon a stretched diaphragm. While it is true that the velocity microphone has an output (about -98 db.) lower than that of other types, still, no more than two stages of amplification are necessary to attain the necessary sound level.

In addition to its splendid frequency response, there are many reasons why the amateur should construct and own a velocity microphone. This superior instrument can be built up for less than the cost of an ordinary "mike." It is impossible for the velocity microphone to "pick" and there cannot be any "hiss" or "background noise." The velocity microphone is not sensitive to mechanical vibrations and hence it does not require a spring mounting.

Velocity microphones respond only to sounds directly in front of them—that is over a 100 degree arc. This eliminates the possibility of "feed back" troubles and also makes the instrument suitable for many classes of work where certain objectionable external sounds must be excluded. Talking motion picture work is an excellent example of this kind.

The velocity microphone requires no polarizing or exciting voltage. It may be used at a distance of up to 250 ft. away from the pre-amplifier without additional pre-amplification.

The velocity microphone illustrated has an output level of -98 db. These instruments are more rugged than any of the other types of microphones. They will stand all kinds of shocks and rough treatment and are not affected by climatic or atmospheric conditions as in the case of certain other types. Due to these special advantages, velocity microphones are especially desirable for use in connection with mobile and portable P.A. systems.

Although some experimenters may desire to construct one of these "mikes" by hand, very little is to be gained by this, because of the fact that the Bruno Superior Ribbon Microphone Kit, upon which this article is based, is available at a nominal cost.

THE TALKING CANARY

(Continued from page 329)

able output. Outside the store, a dynamic speaker can be concealed. Some experimenting will have to be done as to the high notes, since not all speakers will respond to the extremely high notes of canary birds. The proprietor of the store is then told that he will get a tremendous attraction by having one of his best canary birds sing all over the block. To accomplish this, one of the store's best birds is then put in the cage, and the singing effect is produced outside of the store. Unless the sounds are entirely too loud, so that they will annoy the neighbors, they will usually not object to the sound of canaries whistling in the street.

Another variation is to have another bird cage hanging outside the store, with a singing canary and a Baldwin unit installed in it. This end is connected also to the master bird's cage, and through an amplifier. It will be found that the Baldwin unit can stand quite a good bit of overload; and the music which will issue from the street bird's cage will be loud enough to attract passersby; who will wonder how a canary can possibly sing so loud—not being informed, of course, that it is really a second canary, concealed inside the store, who is doing the actual singing.

While primarily, owners of bird and animal shops will be interested in such an amplifying scheme, there is no reason why radio shops and other stores, for that matter, cannot use the same scheme to arouse attention.

In most cases it will be found a good investment as a novel advertising device, to interest passersby who will wonder how it is done. It is then up to the merchant, by his window display, to get the customers into his store.

Increase YOUR SERVICING BUSINESS 25%

If you are overlooking servicing auto radios, then you're missing a great deal of business. The auto-radio business had its greatest boom this past summer and thousands of sets were sold. By this time many of these same sets require servicing and with hundreds of them same right in your own community, you can build up a good auto-radio servicing business. In a short time you can easily add 25% or more to your regular servicing business.

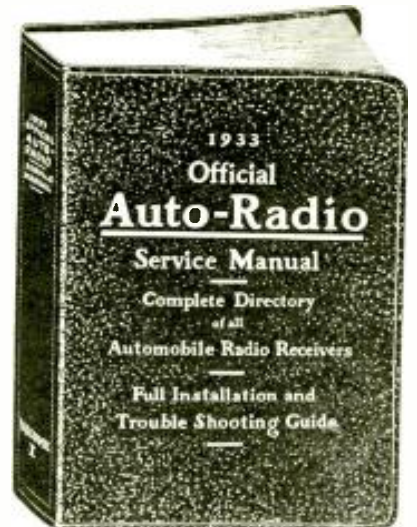

\$2.50
a Copy

Every man connected in any way with the booming auto-radio business will want a copy of this book immediately. It is devoted exclusively to auto-radio service "done" in complete, understandable form. The OFFICIAL AUTO-RADIO SERVICE MANUAL contains schematic diagrams, chassis layouts, mounting instructions, and trouble shooting hints on all 1933 and many older model auto-radio receivers. This Manual contains a "goldmine" of information.

List of Sets Covered in the Manual

| | |
|---------------------------|----------------------------|
| Atwater Kent Mfg. Co. | Chas. Hoodwin Company |
| Autocrat Radio Company | Montgomery Ward & Co. |
| Carter Generator Corp. | National Co., Inc. |
| Chevrolet Motor Company | Philo Radio & Tel. Corp. |
| Proley Radio Corp. | Pierce-Airo, Inc. |
| DeLoe Appliances Corp. | Premier Electric Co. |
| Emerson Electric Mfg. Co. | RCA-Victor Co., Inc. |
| Federated Purchaser, Inc. | Sentinel Radio Corp. |
| Fada Radio & Elec. Corp. | Sparks-Willington Corp. |
| Ford-Majestic | Stewart Radio & Tel. Corp. |
| Franklin Radio Corp. | United Amer. Bosch Corp. |
| Galvin Mfg. Corp. | United Motors Service |
| General Electric Co. | U. S. Radio & Tel. Corp. |
| General Motors Corp. | Wells-Gardner Company |
| Grigsby-Grunow Co. | Zenith Radio Corp. |

Over 200 Pages
Over 500 Illustrations
9x12 Inches
Flexible, Loose-Leaf Cover

Mail This Coupon Today!

GERNSBAK PUBLICATIONS, Inc. RC-12
90-98 Park Place, New York, N. Y.

Enclosed you will find my remittance of \$2.50 for which please send me one copy of the 1933 OFFICIAL AUTO-RADIO SERVICE MANUAL. (Send remittance in check or money order. Register letter if it contains cash or currency. WE PAY POSTAGE.)

Name

Address

City State

SERVICEMEN RADIO DEALERS



SEND FOR THIS

**FREE
CATALOG!**

IT'S CHOCK-FULL

of BARGAINS FOR YOU

Radio Dealers and Servicemen can't afford to be without this book. It offers marvelous buys in Radio Sets, Long and Short Wave Apparatus, Servicemen's Repair and Replacement Parts, Electrical Goods, Sporting Goods.

Just Off The Press!

Be among the first to have the pick of great bargains. Mail this coupon now!

RADIO CIRCULAR CO., INC.
225 Varick Street
New York, N. Y.

Dept. RC-12

Please send me free of charge and without obligation, your latest catalog.

Name
Address
City..... State.....

Classified Advertisements

Advertisements in this section are inserted at the cost of twelve cents per word for each insertion—name, initials and address each count as one word. Cash should accompany all classified advertisements unless placed by a recognized advertising agency. No less than ten words are accepted. Advertising for the January 1934 issue should be received not later than November 9th.

BUSINESS OPPORTUNITY

FIRM, 8 YEARS ESTABLISHED, SELLING to specialists all over Spain, solicits offers for radio sets, popular types. Churruarín Y Salaverria, Eibar, (Spain).

POWER SUPPLIES

A.C. POWER, less than \$5.00. Build a 300-watt, 110-volt, 60-cycle, public address or light generator. Complete plans \$1.00. A.C. Power, P. O. Box 382, Vincennes, Indiana.

RADIO

RADIO PARTS—WE CARRY EVERYTHING for receiving and transmitting. Wedel Company, Inc., Wholesale, Seattle, Washington.

RADIO TALENT

UNDISCOVERED RADIO TALENT WILL BE given encouragement, opportunity and management. Microphone and cabaret audience provided free at 11 West 51st Street, in Radio City, Nellie Edwards, New York, N. Y.

SEXOLOGY

THE MAGAZINE OF SEX SCIENCE

SEXOLOGY, foremost educational sex magazine, is written in simple language and can be read by every member of the family. It is instructive, enlightening—not a risqué book—contains no jargon. Devoted to Science of Health Hygiene.

Contains 25 important articles on Sex Science, 68 pages, with attractive two-color cover. Here are a few of the more important articles: "Sex Prohibition," "The Mechanics of Conception, Test-Tube Babies, Sexual Stimulants, Mannish Women and Womish Men, Painful Menstruation, The Church and Sex, Sex Secretions and Hair, Sex Life in Middle Ages, Sex and Smell, Nudism Restores Balance, Legalized Abortion, etc.

Get a copy of SEXOLOGY on any newsstand, or, if your dealer cannot supply you, send 25c in stamps for a copy of the current issue.
SEXOLOGY 25R West Broadway New York, N. Y.

REMOTE CONTROL

(Continued from page 350)

the receiver may be tuned and controlled from any desired remote point or points, merely by pressing push-buttons. The device turns the set ON or OFF, accurately tunes in any one of the six pre-selected stations, and increases or decreases the volume. Manual tuning, other than necessary for the original setting of the selector buttons is entirely eliminated.

This remote-control outfit is made by the Westinghouse Electric and Mfg. Company.

Referring to Fig. 1A we see the normal position of the motor armature. It will be noted that a spring holds the armature so that the gear at one end is meshed with the volume-control gears. At 18 V., the voltage used for volume-control operation, the gears remain in this position and the operation of the volume control is secured. When the speed of the motor is increased, by operating it at 23 V., this voltage being used when the selector buttons are pressed. The end thrust of the armature causes it to move laterally, thereby disengaging the gear at the volume-control end and engaging the gear at the station-selector end. This is shown in Fig. 1B. The spring at the end of the armature always causes it to return to the volume-control position when the current is OFF at the motor. As this action takes place with the motor operating in either direction, controlling the voltage at which the motor is operated determines its function. A 60 ohm resistor is placed in each motor circuit controlling the volume, to reduce the voltage from 23 to 18 V.

The Selector Controls

The proper direction of operation and the stopping of the motor for selection of a desired station is controlled by a series of drums and contactors. Figure 1C shows a schematic diagram of the motor and its adjacent circuits. The drums hold the contactors in the proper position so that when a particular selector button is depressed the motor will turn in the right direction. When the contactor is at the point of the drum where it is half-way between each contact, the motor stops. This is 180 degrees from the hole and is used to set the drum for a particular station.

The setting of the drums is made by the pins on the front panel. These are designated as "setting buttons." The selector button is pressed and the drum is moved by the motor until the corresponding contactor is midway between the contacts. The setting pin will now fall into the hole in the drum. If the setting button is depressed, (See Fig. 2.) By holding the pin firmly in the hole, the desired station is accurately tuned in by means of the manual station selector knob; or simply by manually rotating the gauged tuning condensers by firmly grasping the rotor plates. When the desired station is thus tuned in, the pin is released. Thereafter, pressing the corresponding selector button will always bring the drum back to the position for which it was set.

A common lead is used for the pilot lamp and the selector buttons in the remote control box. In this way, when a selector button in the box is pressed, the current through the common lead is increased and hence the voltage drop in the lead is increased. The result is that while the motor is running, the pilot light becomes very dim. As soon as the motor stops, the lamp flashes bright, thus indicating that the desired station is tuned in. If the station is then not heard, it is simply necessary to press the "plus" volume control button, releasing it when the desired output level is obtained.

The contactor drum shaft is coupled directly to the shaft of the gauged tuning condenser of the receiver. Although it is feasible to use the fiber gear with a small pinion attached to the condenser shaft, this may be dispensed with in order to simplify the procedure. In this case, the gear is removed from the drum shaft by knocking out the small tapered pin which holds it to the shaft. A standard metallic coupling adapter, furnished with the control, is then fastened on the drum shaft, and the shaft of the condenser is secured to the other end of this coupling.

Build the 1934 DENTON ULTRA- MODERN SUPER-HET

Why wait six months or a year for a factory-built set containing today's wonderful advances in radio engineering, when you can have them all—right now—in Clifford E. Denton's 1934 Ultra-Modern Super.

This carefully engineered custom-built receiver, which has been developed over a period of four years, has again been improved by the addition of up-to-the-minute engineering features plus the latest and most efficient tubes.

A FEW FEATURES

| | |
|--|--|
| Improved Automatic Volume Control Circuit | Remarkable Selectivity and Sensitivity |
| New 2A7 Tube Combining Oscillator and First Detector | Smooth Operation |
| Tuning Meter | Great Stability |
| New 2A6 Second Detector | High Efficiency |
| Silent Tuning Switch | Enormous Volume if Required |
| Band Pass Input—Nine Tuning Circuits | Provision for Phono Pick-up |
| | Superb Tone Quality |

ALL PARTS FOR THE 1934 ULTRA-MODERN SUPER IN STOCK—PARTS MAY BE PURCHASED SEPARATELY OR AS A COMPLETE KIT

COMPLETE KIT INCLUDES

| | |
|---|------------|
| 1—00035 mfd. Four Gang Tuning Condenser, No. 6654 | \$2.05 |
| 1—750 mfd. Micaoid Condenser, type 6635 | .12 |
| 1—50 mfd. Micaoid Condenser, type 6629 | .10 |
| 3—250 mfd. Micaoid Condensers, type 6632 | @ .10 .30 |
| 1—006 mfd. Micaoid Condenser, type 3148 | .24 |
| 1—Micaoid Trimmer Condenser, type 2883 | .12 |
| 1—1 mfd. Electrolytic Condenser, type G1100 | .32 |
| 3—1 mfd. 200 volt Aeratest Cartridge Condensers, type 5637 | @ .10 .90 |
| 1—1 mfd. 400 volt Aeratest Cartridge Condenser, type 5616 | .13 |
| 1—25 mfd. 200 volt Aeratest Cartridge Condenser, type 2835 | .12 |
| 1—.02 mfd. 400 volt Aeratest Cartridge Condenser, type 5611 | .10 |
| 1—10 mfd. 25 volt Aeratest Electrolytic Condenser, type 6645 | .20 |
| 2—8 mfd. 500 Peak Volts Aeratest Electrolytic Condensers, type 5308 | @ .51 1.08 |
| 1—Aeratest Kit of Band-Pass and Detector-Oscillator Coils, No. 6651 | 1.75 |
| 1—Aeratest R.F. Choke, type 2871 | .17 |
| 3—Aeratest 175 kc. I.F. Transformers, type 5358 | @ .35 2.85 |
| 1—Frost Volume Control with Power Switch, type 6175 | .95 |
| 1—Special Protected Chassis with holes drilled for sockets and Power Transformer, type 1297 | 1.00 |
| 1—Aeratest Power Transformer, type 2527 | 2.75 |
| 1—30 Henry, 75 ma. Aeratest Audio Choke, type 2505 | .45 |
| 1—Rotary Snap Switch, No. 5284 | .25 |
| 1—Aeratest Push-Pull Input Transformer, type 5834 | .95 |
| 1—Aeratest Tuning Dial, type 1047, for large condenser shaft | .90 |
| 5—Screen Grid Clips | .06 |
| 5—Aeratest Tube Shields, type 1173 | @ .20 1.00 |
| 1—Four-Prong Socket, marked 80 | .05 |
| 2—Six Prong Sockets, marked 2A5 | @ .05 .10 |
| 1—Five-Prong Socket, marked 6X8 | .05 |
| 2—Six Prong Sockets, marked 58 | @ .05 .15 |
| 1—Seven Prong Socket, marked 2A7 | .05 |
| 1—Six Prong Socket, marked 2A6 | .05 |
| 1—Alden Short Plug and Cap, type 5869 | .20 |
| 6 ft. Power Cord and Plug, type 1304 | .15 |
| 1—Eby Antenna-Ground Strip, type 5689 | .11 |
| 1—500 ohm, 1/2 watt Aeratest Resistor, type 5860 | .08 |
| 3—350 ohm, 1/2 watt Aeratest Resistors, type 5880 | @ .08 .24 |
| 2—20,000 ohm, 1 watt Aeratest Resistors, type 3500 | @ .08 .16 |
| 1—50,000 ohm, 1/2 watt Aeratest Resistor, type 5860 | .08 |
| 3—1/2 meg., 1/2 watt Aeratest Resistors, type 5860 | .24 |
| 1—50,000 ohm, 1 watt Aeratest Resistor, type 3500 | .08 |
| 1—1 meg., 1/2 watt Aeratest Resistor, type 5860 | .08 |
| 1—5000 ohm, 1/2 watt Aeratest Resistor, type 5860 | .08 |
| 1—200 ohm, 2 watt Aeratest Resistor, type 5185 | .08 |
| 1—Frost Potentiometer, 1/2 meg. type 6160 | .45 |
| TOTAL | \$21.04 |

Net Price of above parts if purchased in one kit. Only **19.45**

| | |
|--|--------|
| 1—Headline Tuning Meter, 0-10 ma. type TM-120 | \$1.20 |
| 1—Complete Set of Eight Matched Raytheon Tubes for 1934 Ultra-Modern Super | \$6.85 |
| 1—Matched Dynamic Speaker—1 1/2 inch dia., No. 529 | \$3.70 |

All our branches carry a complete line of broadcast radio sets and parts, replacement parts, short wave receivers, tubes, public address equipment, meters and other radio supplies. Send for our complete 108-page FREE catalog, **Servicemen!** Have you received your free copy of the new Aeratest Book on Public Address and Sound Equipment? If not, write for it at once.

FEDERATED PURCHASER, Inc.
25R Park Place New York, N. Y.

SERVICEMEN

Here are the new improved essential parts for the New Revised Radio-Craft Universal Analyzer. See page 218 of October issue.

- 907WLA New Small 7-pin Latch-Lock Analyzer Plug complete with 5 ft. 8-wire cable... List \$5.50
- 974DSA, 975DSA, 976DSA, and 977DSA List 5.90
- 456B Composite 4-5-6 Button Socket... List .50
- 427 Medium 7-contact Button Socket... List .25
- 427A Small 7-contact Button Socket... List .25
- 91 Do Luxe Insulated Screen-Grid Clip... List .25



Now is the time to modernize all of your test equipment. Don't delay any longer. Here are kits priced to fit every serviceman. Directions and diagrams included with all outfits. Each adapter has a bi-color ring with distinctive color-band between heater holes to enable any adapter to be quickly joined to the analyzer plug.

Here is the professional model. Used on the latest Weston, Jewell, Hilekok, Supreme, etc., testers. If you want the best get this kit. Has the famous Na-Aid Latch-Lock with thumb release.

- 907WLA New small 7-prong Latch-Lock Analyzer Plug with Twin List \$4.50
- 974DSA 7A to 4-prong Latch Adapter... List 1.25
- 975DSA 7A to 5-prong Latch Adapter... List 1.25
- 976DSA 7A to 6-prong Latch Adapter... List 1.25
- 977DSA 7A to 7-prong Latch Adapter... List 1.25
- 907WLA KIT Complete as shown... \$8.50

Here is the set for those who want the lowest possible price. The Handle Plug with the wired type "Make-Your-Own" small diameter as-ohm adapters. Increased adapter height permits easy removal when left in socket. C. G. stud supplied.



- 977P 7-prong Plain-Type Analyzer Plug... \$.40
- 974W 7 to 4-prong Wired Adapter... .55
- 975W 7 to 5-prong Wired Adapter... .55
- 976W 7 to 6-prong Wired Adapter... .55
- 977WA 7 to 7A-prong Wired Adapter... .55

977P KIT Complete as shown... \$2.60

8-Wire Braid-Covered Analyzer Cable... List \$1.00

REPLACE YOUR OBSOLETE SOCKETS WITH THESE LATEST COMPOSITE SOCKETS

456 4-5-6 Contact Composite Socket... List 50c ea
477 7-7 Contact Composite Socket... List 50c ea

It's here at last!—The "Make-Your-Own" Adapter Kit. All the parts for making any required adapter, including all ten types of socket top-sections and small sized base-sections complete with over two dozen assorted extension, soldering, connection, plug-ends and control-grid terminals, connectors, clips and lead wires. 900 "Make-Your-Own" Adapter Kit complete. List... \$2.50

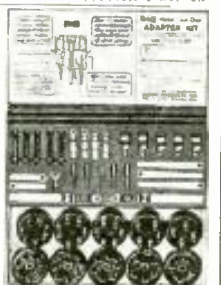

GET THIS ADAPTER TO MODERNIZE YOUR TUBE CHECKER

950XYL Universal Tube Checking Adapter Tests over 100 NEW TYPES of tubes—no leads—no jacks—very simple to operate—circuit diagram and direction chart listing over 100 NEW TYPES with spaces for recording readings of these and future tubes are supplied with all orders. List Price... \$6.00



950TR TRANSFORMER-TYPE TUBE-CHECKING ADAPTER

Has self-contained filament transformer and voltage switch for testing all 10 to 30 volt tubes in any type 24 tube-checker socket. Use you tubes 25Z5, 43, 48, 12Z6, 11, 17, 18, A22, A26, A28, A30, A32, A10, A18, AE, HZ50, RA1, 801, 25Z3, 96, 262A, 272A, etc. If not, you need the 950TR adapter. Direction and reading chart on base of adapter. Get yours now and be able to check all the new high filament voltage tubes. List Price... \$6.00



HERE'S THE DATA YOU WANT

Send two 3c stamps for new Booklet showing illustrated tube socket connections of over 200 different types of tubes, data on rewiring obsolete set analyzers and using new tubes in place of old types. Includes: retainer rings on all kinds of individual and composite sockets, speaker slugs, connectors, sound and unwound plug-in coils, coil winding data and S-W and B-C receiver circuit, etc.

ALDEN PRODUCTS CO.
Dept. R-12, 715 Center St.
BROCKTON, MASS.

The Volume Control

If the radio receiver uses a volume control of approximately 3000 to 5000 ohms resistance, disconnect the leads from the set volume control, lengthen them if necessary and solder them to the volume control furnished with the remote control. The small brown resistor, also furnished with the remote control, has a resistance of approximately 5000 ohms and this may be connected in series as an additional external fixed resistor, if required.

However, if the receiver volume control has a much higher or a much lower resistance than the one supplied with the remote control, or if it is deemed preferable to retain the receiver control, this may be done by removing the volume control furnished with the remote control unit, by forcing out the tapered pin which holds its shaft to the collar. The set volume control is removed and is substituted in place of the one just removed from the remote control. It is put into place and the hole in the collar is used as a "jig" for drilling a hole through the volume control shaft. The pin is replaced, thus fastening the set volume control securely to the collar and the metal gear. The volume control leads are extended from the set and resoldered to the volume control in its new position.

The third and last operation consists of removing the special three-prong plug from the three-wire A.C. cable. One of the wires is also removed from the two-prong 110 V. plug used for supplying current to the set. This wire is connected to the green wire of the remote control cable. The black wire from the remote control cable is put into the two-prong plug in place of the wire which was removed. The yellow wire is then connected to the other side of the two-prong plug—that is, to the side also connected to the set. The diagram shown in Fig. 1D makes this quite clear.

Reviewing the procedure outlined above, it will be seen that this resolves itself into three simple operations, regardless of the make or type of radio receiver to be equipped with this remote control. First, a simple mechanical connection between the drum shaft of the remote control and the condenser shaft of the single dial control set. Second, the substitution of the set volume control for the one on the device and the resoldering of a few wires. Third, removal of a three-prong plug and substitution of a standard two-prong plug. The only other connections to be made are the 12 wires from the 25 ft. flat cable to the remote control cable terminal strip. These 12 wires terminate in lugs which are held tightly in place on the terminal strip by means of brass screws. By referring to Fig. 1E, the connections may be easily followed.

Quality and Selectivity

In Fig. A is illustrated the Lafayette remote control P.A. tuner, especially designed around the aforementioned unit which immediately creates a potential market for the wide awake service or sound specialist. This unit embodies all of the features of the remote control just described, in addition to those of the P.A., T.R.F. selector.

There are many applications for a device such as this in hotels, clubs, P.A. systems, and for "radio pick up for theatres." The advantages are obvious at once, for, in almost every large sound installation it is inconvenient for the operator to be near the "rack" or amplifier room. Therefore, with the above arrangement, in the case of the hotel installation, the desk clerk can operate the radio system without leaving his position. This is a great sales point on this tuner or any other device employing the remote control! For the deluxe home installation, this unit lends itself well, as it can be installed in the wall behind any concealing object, and the owner can tune his receiver from various parts of the room, as far as that is concerned.

Remote Control

A schematic diagram of the tuner employed in the remote control rack mounting assembly is shown in Fig. 3, and it is at once apparent to the technically inclined that this unit was designed for good audio response, as the familiar T.R.F. circuit is employed. In deluxe sound installations, it is necessary for the frequency characteristic of the amplifier to be

FREE!

Choice of One or More of These Popular Short Wave Books

Here's money put right into your pocket—here's a saving you never gave a thought to. You get absolutely FREE any one or more of the regular 25c and 50c short wave books with a year's subscription to SHORT WAVE CRAFT, the Radio Experimenter's Magazine. A one year's subscription brings you one fifty-cent book or two twenty-five-cent books; a two-year subscription brings you two fifty-cent books and any one twenty-five-cent book. Decide NOW what books are most necessary to you—then send us your subscription by return mail. The books will be sent to you immediately.

25¢ The Copy

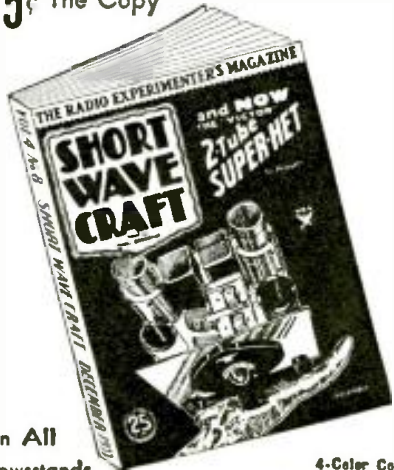

On All Newsstands

4-Color Cover
9" x 12" in Size
Over 200 Illustrations



No. 1 50c
No. 2 50c
No. 3 25c
No. 4 25c

THIS popular short-wave magazine interests the great army of "ham," broadcast listeners, and general radio students who are interested in experimental as well as scientific angles of short wave development and application. In each monthly issue appears the largest and most correct short-wave station call list, and important construction articles on receivers and transmitters, including "pictures" diagrams easily understood by anyone, a big feature "originated" by SHORT WAVE CRAFT. You'll also find the latest news about short-wave physics, micro- and ultra-short waves and other applications of this newest branch of radio.

Many Short Wave Sets to Build

Many excellent short-wave sets with complete construction details with "picture" diagrams, are found in every issue—these sets vary from simple one- and two-tube sets to those of more advanced design, five and eight tubes.

Big Silver Trophy FREE!

Recently inaugurated by Mr. Hugo Gernsback, Editor, was the "Short Wave Scout Contest." To the Short Wave "fan" who has logged and obtained verification of the largest number of short-wave stations from all over the world, during one month, will be awarded a magnificent silver Short Wave Scout Trophy.

Mail This Coupon Today!

SHORT WAVE CRAFT, Dept. RC-12
96-98 Park Place, New York, N. Y.

Gentlemen: Enclosed you will find my remittance for a subscription to SHORT WAVE CRAFT for

[] One Year @ \$2.50 (Canadian and foreign \$3.00)
[] Two Years @ \$5.00 (Canadian and foreign \$6.00)

Send me FREE books which are circled below.

1 2 3 4

Name

Address

City State

(Send remittance in check or money order. Register letter if it contains cash or unused U. S. Postage Stamps.)

BEER—

A NEW MONEY MAKING BUSINESS

for Radio Service Men

Here is a new all-year-round money-making opportunity for men who have vision and foresight.

With the legal sale of beer now practically established in every state, and rapidly growing into a large sale industry, all restaurants, cafes, bars, clubs, and hotels are faced with the problem of properly conditioned equipment to keep good beer from sourness, bad taste and other deterioration resulting from uncleanliness.

The pipes and coils through which beer is pumped have to be kept meticulously clean. In many states there are very drastic regulating laws as to how many times each week all beer pipes and coils have to be cleaned in any establishment where beer is sold.

And here is where you Service Men come in to make money!

SET YOURSELF UP IN THE BEER-PIPE CLEANING BUSINESS.

All you need is our new, unique, compact, portable BEER PIPE-COIL CLEANER.

Go and visit our local restaurants, cafes, bars, clubs, and hotels, and make a service contract with the proprietors to clean their equipment once or twice a week, or oftener, at a fixed charge.

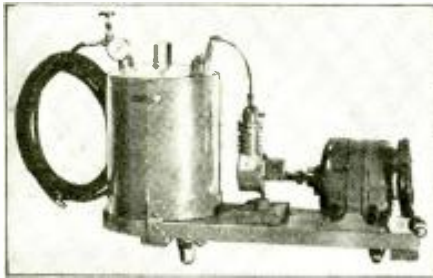

The price you pay for your BEER PIPE-COIL CLEANER will come back to you in earnings in a very few days of work, and every cent you take in after that will be clear profit—BIG MONEY FOR YOU!

The BEER PIPE-COIL CLEANER here described is scientifically constructed to do a thorough job of cleaning beer pipelines, coils, and faucets. It is ruggedly built for hard use and long service. There is nothing to get out of order.

We fully guarantee every one of our BEER PIPE-COIL CLEANERS against defects in either material or workmanship.

This portable apparatus consists of a 1/4 H.P. motor, a DIRECT DRIVE compressor, and a water-tank. The tank is provided with water-intake plug; pressure gauge; on-off, safety valve; water outlet faucet and hose connections for coil. The entire equipment weighs 42 lbs., and measures 27" in length, 11" in width and 18" in height. Shipping weight 55 lbs.

The whole outfit is portable, and mounted on a base equipped with small wheels.

To use the apparatus, all you have to do is to plug your motor into any A.C. light socket, fill the tank three-quarters full of hot or cold water (to which you may add ammonia, sal soda, or any cleansing compound), start your motor until your gauge shows about 40 lbs. of air pressure, connect the empty beer line with your tank, open the beer faucets and force the cleansing fluid through the pipes and coils. Repeat the operation with clear water, and blow out the coils and pipes with air. This is all there is to it.

Under our introductory offer here announced for the first time this whole service equipment described above will be sold for a limited time at the special price of

\$37.50

(Shipped by Express or Freight Collect)

In any new business venture, one of the prime elements of success is to get in on the ground floor. Be the first one in your city to start this new service business! Cash in on the start! If you work it right, you will make a lot of money, and you will have work to keep you busy summer and winter.

Send us your order now, using the order blank below.

ORDER BLANK

WELLWORTH TRADING CO.
111 W. Lake St., Chicago, Ill.

RC-12

Enclosed find \$37.50 for which please ship me by express or freight one of your BEER PIPE-COIL CLEANER outfits.

Name

Address

CityState

essentially flat between 40 and 10,000 cycles, and as there are any number of amplifiers on the market today capable of meeting these requirements, this phase presents no problem. However, when we consider the tuner, we are presented with an entirely different condition.

Present day broadcasting allocations are such that a very selective receiver is required in order to separate the various stations from each other, and radio receiving engineers have met this condition with an offensive unit, which is quite effective, in the form of the superheterodyne. This set, while it fulfills the desired from a selectivity angle, falls flat when a frequency characteristic such as stated for a deluxe amplifier, is required. The average superheterodyne does not respond to audio frequencies above 5000 cycles, and hence does not reproduce the high notes sufficiently to afford the highest quality reproduction. Therefore, there is only one solution to a problem of this nature regardless of how much "higher mathematics" is employed, and that is to use a circuit which will afford an audio frequency response as good as that of the amplifier.

But, the average reader may remark: "Of what use is this superb quality if you cannot separate the stations." The answer is: "none whatsoever." Naturally, this is not the case here, as a factor so important could not be overlooked. While it is true that the selectivity of this tuner is not equal to that which can be obtained in the most elaborate superheterodynes, it is nevertheless more selective than many of the superbets which the author has had the pleasure of testing. This unusual selectivity is accomplished by employing a four-gang condenser in a specially designed circuit consisting of a highly selective double-tuned band-selector stage, together with two tuned stages of R.F. using unusually selective Hitz wound R.F. transformers. Two type 58 R.F. pentode tubes are employed as amplifiers in this arrangement which also aid in making this tuner selective by virtue of their remote cut-off feature, effectively reducing cross modulation. A type 57 general purpose tube is employed as a linear detector, the output being fed directly to the grid of the input tube of the amplifier. The extremely high input impedance of the 57 tube further enhances the selective quality of this tuner.

A filament transformer is supplied with the complete assembly, as the "B" supply is invariably obtained from the power supply of the amplifier. If for any reason it is necessary to obtain the power elsewhere, this can be done very easily by constructing a small auxiliary supply which will deliver 200 to 250 V. at 25 ma. A cathode type of volume control is employed in the tuner, and in the majority of cases this will always be kept approximately one-quarter of the way on, which further reduces the strain on the power supply, as the current drain at that point will be about 10 ma.

The panel dimensions are such that the remote control tuner will fit a standard W.E. rack, being 20 1/2 x 9 ins. high. The overall dimensions of the chassis are 17 1/2 x 8 1/2 x 8 ins. high. In the event it is desired to mount this unit in a console, the panel can be discarded.

In conclusion, it is apparent that the remote control is easy to sell because it possesses logical and compelling sales features. It is a convenient and useful development in radio, and it appeals to the universal desire to be up-to-date. It may be used to eliminate old style, unsightly cabinets, since the set equipped with remote control may be installed in a closet, in the attic, or in any other out of the way place.

From the listeners' standpoint, remote control adds immeasurably to the utility of the radio set. The receiver in the living room may be operated from the bedroom, by means of a control box alongside the bed. A control box placed near the easy chair permits changing from one program to another merely by pressing a button. Even distance fans can utilize the pre-selector feature of the remote control, to enable them to bring in a distant station night after night, once it has been located, so that the selector tunes to it.

KEEP UP TO DATE
with
RADIO-CRAFT

RADOLEK'S

NEW LINE OF AMPLIFIERS

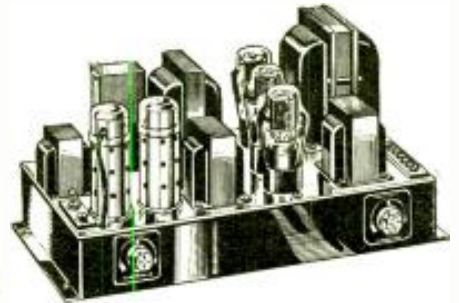

This 15-WATT
3-STAGE MODEL

Dealer's Price
Less Tubes
ONLY

\$32.40

- PUSH-PULL 2A3s
- IMPROVED CLASS A PRIME
- 30 WATT SPEAKER FIELD SUPPLY

One of the finest 15 Watt Amplifiers ever produced—yet lower in price than previous Amplifiers far less efficient and well made. Most Power per dollar, with matchless Tone. For use with Microphone, Phonograph or Radio. Drives 3 large Dynamic Speakers, 8 small Dynamic Speakers, 3 Dynamic Horns, 134 Magnetic Speakers, or 2,000 Headsets; or any combination of these. Furnishes 30 watts for Dynamic Speaker Field supply. No external chokes required. Has output impedance tapped at 3, 6, 9, 15, and 500 ohms. Gain at 1,000 cycles, 77DB. Frequency characteristic within 3DB, 50 to 8,000 cycles. Tubes used: 1-58, 1-57, 2-2A3s, 1-5Z3. Overall size 9x16x8 inches.

YOUR PRICE COMPLETE WITH CUNNINGHAM TUBES **\$39.67**

GET OUR BIG CATALOG

Radio Dealers and Servicemen: The new Radolek Profit Guide is now ready! Don't delay sending for your FREE copy. It is the most complete guide to Radio merchandise ever published. Lists over 6,000 various items—Replacement Parts, Tools and Materials, Testing Equipment, Money-making Specialties, Public Address Equipment and Radio Sets. Also contains many handy charts, booklets, tables, and diagrams that you will have use for every working day.

Fill Out and Mail the Coupon Today!

RADOLEK CO., 132 Canal Station, Chicago

I am a Dealer [] Serviceman []

I operate from Shop or Store []; from Home []

I can take the following Test Equipment.....

My training and experience is:.....

.....

Name

Address

CityState



5 DAYS FREE Trial

.. BUD LOUD SPEAKERS

NORMAL efficiency 2 1/2 to 25 watts—peak capacity 50 watts! BUD'S new diaphragm and voice coil assembly assure higher efficiency and far greater dependability! Write for literature on BUD units, all aluminum, weatherproof "NATURAL-TONE" trumpets, microphones, extenders, air column horns.

Get details of Five-Day Free Trial and Information on our new high frequency theatre unit.

BUD SPEAKER CO.
1144 DORR ST.
TOLEDO, OHIO-U.S.A.



Outside View
of
Aircraft Generator

BARGAIN SALE of 3000 WESTINGHOUSE Power Generator Aircraft Transmitters

Hundreds of Uses for
Radio Experimenters

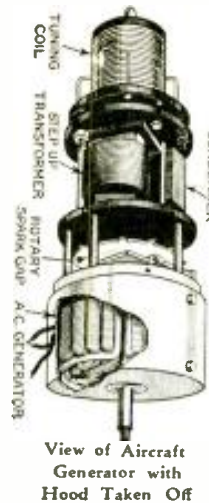

View of Aircraft
Generator with
Hood Taken Off

The Government Paid Originally \$147.00 Each
for these Westinghouse Generators

OUR PRICE \$4.95
AS LONG AS SUPPLY LASTS EACH

Technical Specifications

The special generator illustrated is of the self-excited inductor type. The rotor serves two entirely distinct purposes: 1. It carries the inductors for the A.C. generator, which has stationary field and armature coils. 2. It carries the D.C. armature, which corresponds to the exciter in other machines.

There are two pairs of stator poles—two North and two South. Around these four poles are wound the four field coils which, when energized, produce poles of alternate polarity. Each of these poles is provided with four slots into which are fitted the A.C. windings. The rotor is a 12-tooth inductor that carries the D.C. exciter current required by the alternator; a built-in commutator takes off the generated D.C. Three leads extend through the casing to permit a 4½ V. flashlight-type battery to be switched into circuit for starting, and to control the A.C. output of the generator. Rotated at its normal speed of 4,500 r.p.m., the output is 200 W., at 115 to 125 V. (on open circuit), 900 cycles.

Manufactured by Westinghouse for the U. S. Signal Corps, the sturdy construction of this instrument recommends it to the technician. The rotor turns in ball bearings. In order to perfectly withstand the extremes of temperature and humidity encountered in air-craft service all the coils are thoroughly impregnated with a special compound and then baked. Shaft length (driving end), 2 ins.; diameter, 9/16-in.; the end is

threaded for a distance of ¾-in. At the end opposite from the drive the shaft extends ¼-in. Case dimensions, exclusive of the shaft, 4½ x 6 ¼ in. in diameter.

The output of this self-exciter generator is fed to a step-up transformer which, in turn, is fed to a 12-point synchronous rotary spark-gap;

a rocker permits the single stator point to be accurately adjusted to phase the spark and the power supply. The spark-gap is included in a secondary that comprises a mica fixed condenser, and a tapped tuning inductance adjustable in the range of 250

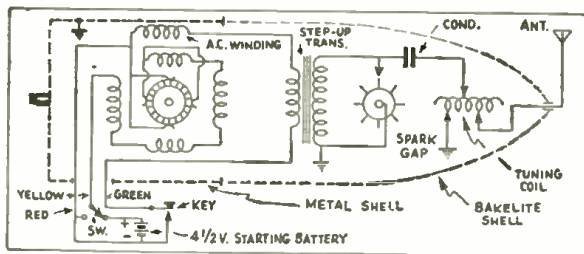

to 550 meters. This coil consists of 25 turns of No. 14 wire wound on a threaded bakelite form 3 ins. in diameter and 3 ins. long; the over-all length is 4½ ins. One set of taps is brought to a contact plate at one end and provided with a switch; the other set is brought to a contact plate at the opposite end and provided with a pair of laboratory-adjusted contacts. A stream-lined bakelite housing slips over the entire transmitter assembly. The over-all length of generator (exclusive of shaft) and transmitter is 18 ins. Weight of complete outfit, 20 lbs.; shipping weight, 35 lbs.

WELLWORTH TRADING COMPANY
Dept. RC-12
111 West Lake Street CHICAGO, Illinois

THESE GENERATORS HAVE NEVER BEEN USED AND ARE SHIPPED IN THEIR ORIGINAL PACKING BOXES. THEY ARE FULLY GUARANTEED TO BE AS DESCRIBED ABOVE.

WELLWORTH TRADING CO., Dept. RC-12
111 W. Lake Street, CHICAGO, Illinois

Enclosed find \$4.95 for which ship by express collect one Westinghouse Power Generator Aircraft Transmitter as per your description.

NAME _____
ADDRESS _____
CITY _____ STATE _____

SERVICING "TALKIES"

(Continued from page 347)

paratus that has nothing to do with the amplifier before going on to the amplifier itself.

At the extreme right, on the floor, is seen a can for waste; above that is a bench containing several drawers for tools; above that again a bulletin board by means of which projectionists on one shift communicate with and warn those on another, especially when any part of the equipment is showing signs of trouble. To the left of this bench and bulletin board, on the floor, is a tin case for holding projection carbons of several sizes and types. Mounted on the wall above this are four cabinets which are part of the sound equipment. The right-hand cabinet contains fuses and line switches. The two center cabinets are line voltage regulators. One controls the 110 V. line voltage to each amplifier. Each of the regulator cabinets will be seen to contain a meter (an A.C. voltmeter) and a rheostat handle by means of which line voltage is adjusted as necessary. Below each cabinet is the line "safety" switch by means of which current is applied or cut off.

To the left of these cabinets is a "horn control" cabinet which supplies current to the fields of the loudspeakers. This type of horn cabinet operates to reduce the voltage of a D.C. line. Practically every projection room is supplied with D.C., which is necessary for lighting the projection arc. If a D.C. power line is not available in the community, a motor-generator set or a rectifier capable of supplying up to 60 amps. (unfiltered) is installed. The horn control cabinet contains rheostats to cut this voltage down to the voltage required by the speaker fields. The cabinet in the illustration (Fig. A) will be seen to contain two switches, a meter, a rheostat knob and a bulls-eye signal light. The rheostat knob adjusts the voltage; the meter (a D.C. ammeter in this case) indicates when the correct current is flowing. The signal lamp is provided to help the projectionist find trouble in a hurry. If sound should stop suddenly a glance from any part of the projection room would indicate whether the trouble is in the speaker field circuit or whether that circuit may be eliminated from further investigation. The large switch turns current on and off. The small switch is another safety provision illustrating the immense caution used in theatre equipment to avoid the slightest delay in finding and fixing troubles:—

The speaker fields supplied by this cabinet are all wired in series—to save rheostat losses. Most of these speakers are, of course, behind the screen, and back-stage there are switches by means of which any speaker field that open-circuits can be shorted out of the line instantly. (The voltage is then readjusted by the cabinet rheostat.) But one speaker—the monitor—is in the projection room, and may be seen fastened to the ceiling in the upper left-hand corner of Fig. B. Now, the little switch on this horn control cabinet is wired across the line leading to the monitor field. In case sound stops and the bulls-eye goes out it takes the projectionist only a second to snap this monitor switch and determine whether or not his trouble is in the field of the monitor. Meanwhile a stage employee is closing the short-circuiting switches back-stage, one at a time, and if everything goes as it should the trouble will be eliminated and the show restored in a few seconds.

The other units will be described next month.

10¢ A DAY
BUYS A NEW
REMINGTON
PORTABLE TYPEWRITER
Special 7-Day Free Trial Offer

Think of it! You can buy a new standard Remington Portable Typewriter for but 10¢ a day. Standard keyboard. Small and capital letters. Beautiful finish. Carrying case included free. Exceptional money-making opportunities. Write today. Say: Please tell me how I can get a new Remington Portable typewriter on your special 7-day free trial offer for but 10¢ a day. Remington Rand Inc., Dept. RC-5, Buffalo, N. Y.



• Index to Advertisers •

| | |
|------------------------------------|--------------------|
| A | |
| Aerovox Corporation | 374 |
| Alan Radio Corporation | 370 |
| Alden Mfg. Co. | 376 |
| Allied Radio Corporation | Inside Front Cover |
| Autoerat Radio Company | 374 |
| B | |
| Bud Speaker Company | 377 |
| Burstein-Appelboe Company | 374 |
| C | |
| Central Radio Laboratories | 358 |
| Clark Instrument Company, Inc. | 366 |
| Clarostat Mfg. Company | 358 |
| Classified Section | 375 |
| Coast-to-Coast Radio Corp. | 371, 372 |
| Concourse Electric Company | 371 |
| Coyne Electrical School | 321 |
| D | |
| Deutschman Corp., Toledo | 370 |
| E | |
| Electrad, Inc. | 365 |
| F | |
| Federated Purchaser, Inc. | 375 |
| G | |
| General Transformer Company | 326 |
| Greenpark Company | 383 |
| H | |
| Hammarlund Mfg. Company | 374 |
| Harrison Radio Company | 365 |
| Hoodwin Company, Chas. | 364 |
| Hygrade-Sylvania Corp. | 367 |
| J | |
| Johnson Radio Mfg. Co. | 374 |
| L | |
| Loatome Radio Company | 359 |
| Lynch Mfg. Company | 362 |
| M | |
| McGraw-Hill Book Company | 373 |
| Midwest Radio Corp. | Back Cover |
| Miles Reproducer Company | 368 |
| N | |
| National Radio Institute | 323 |
| National Union Radio Corp. | 361 |
| P | |
| Pemberton Laboratories | 374 |
| Popular Book Corp. | 376 |
| Postal Radio Corp. | 372 |
| Precision Resistor Company | 371 |
| R | |
| Racon Electric Company | 370 |
| Radio & Television Institute | 326 |
| Radio Circular Company | 375 |
| Radio City Products Company | 364 |
| Radio Training Company | 384 |
| Radio Training Association | 362 |
| Radio Tube Exchange of America | 372 |
| Radolek Company | 377 |
| RCA Institutes, Inc. | 368 |
| RCA Radiotron Co., Inc. | 377 |
| RCA-Victor Co., Inc. | 371 |
| Readrite Motor Works | 363 |
| Remington Rand, Inc. | 378 |
| S | |
| S. O. S. Corp. | 374 |
| Sexology Magazine | 375 |
| Shallcross Mfg. Company | 368 |
| Shure Brothers Company | 360, 374 |
| McMurdo Silver, Inc. | 355 |
| F. L. Sprayberry | 366 |
| Stewart-Warner Corp. | 372 |
| Supreme Instruments Corp. | Inside Back Cover |
| T | |
| Tausig, Leo | 366 |
| Tilton Mfg. Company | 372 |
| Triplott Electrical Instrument Co. | 369 |
| Treman Radio Shop | 359 |
| Try Mo Radio Co., Inc. | 365 |
| U | |
| Universal Microphone Company | 372 |
| W | |
| The Webster Company | 365 |
| Wellworth Trading Company | 377, 378 |
| Westinghouse Elec. & Mfg. Co. | 359 |
| Western Electrical Instrument Co. | 361 |
| Wholesale Radio Service Co. | 379 |

(While every precaution is taken to insure accuracy, we cannot guarantee against the possibility of an occasional change or omission in the preparation of this index.)

FAIR BUYING WEATHER NOW

RADIO BARGAIN NEWS



Published by WHOLESALE RADIO SERVICE CO., Inc., 100 Sixth Avenue, New York, N. Y.

10 SENSATIONAL VALUES FROM THE GREATEST CATALOG IN THE RADIO FIELD



RCA VICTOR AUTOMATIC REMOTE CONTROL WITH REMOTE CONTROLLED P.A. TUNER

Turns radio "on" or "off." Accurately selects 6 different stations as well as adjusts volume. Just attach to your present radio chassis. A Bargain that comes once in a lifetime.

No. 12425 **\$12.50**

You can now have a Public Address system complete with

radio, operated from a distant point! Complete Remote Control Tuner as illustrated—less tubes.

No. 15700. **\$37.50**

Price

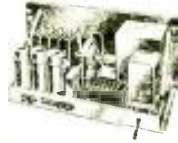

Mershon Electrolytic Condensers

Peak Voltage 430 V

| No. | Capacity | Price |
|-------|-----------|-------|
| D2700 | 8 | 27c |
| D2704 | 8-8 | 69c |
| D2705 | 4-8 | 95c |
| D2706 | 10 | 45c |
| D2707 | 8-8-8 | 95c |
| D2709 | 18-9-9 | 1.45 |
| D2711 | 8-3-18-18 | 2.45 |

EXTRA

JUST OFF THE PRESS

The Biggest and Greatest Catalog every issued by Wholesale Radio Service Company! Over 30,000 items listed! 160 Pages! Thousands of Bargains! Replacement Parts, Sets, Tubes, Speakers, Amplifiers, Kits, all at lowest wholesale prices! Special featured sections on Short Wave, Public Address, Lafayette Receivers, Trust Test Parts.

The world's greatest "Radio Bargain Counter" right at your fingertips!



Send for Yours Today

Dry Electrolytic Condenser Bargains

| INVERTED CAN | | Mershon Electrolytic Condensers | |
|--------------|----------|---------------------------------|----------|
| No. | Capacity | No. | Capacity |
| D2714 | 4 | 44c | |
| D2715 | 8 | 49c | |
| D2716 | 4-8 | 35c | |
| D2717 | 10 | 75c | |
| Cardboard | | Peak Voltage 430 V | |
| No. | Capacity | No. | Capacity |
| D2718 | 2 | 29c | |
| D2719 | 4 | 32c | |
| D2720 | 6 | 42c | |
| D2721 | 8 | 43c | |

Genuine Thordarson Push Pull Input Transformer

Fully shielded in metal case; to couple a stage of straight audio amplification into a stage of power push-pull, using any existing type tubes.

Special. No. C2450 **89c**



Special Audio Transformer

Fully shielded. Excellent frequency response. Especially well made. Straight audio—Bargain Price

No. C1914..... **39c**



Radiola Audio Transformer

For Models RR, Rx, R3, R4, R4, R7B, R9, R20 and R30A. The genuine replacement audio transformer. Universal mounting. A real Bargain.

No. C2006... **29c**



G. E. Condenser 4 1/2 Mfd.—800 Volts

Genuine G.E. Filter Condenser for Amplifiers and P.A. systems. Metal Container. No. B477. **35c**



Power Transformer

Finest quality. Flush mounting type. For 5-6 Tube Sets. Three or four 2 1/2 V. heater tubes, one 2 1/2 V. Power Tube and one 280 or 282 Rectifier.

No. C1492..... **\$1.55**

For 7-8 Tube Sets. Four or Five 2 1/2 V. Heater Tubes, two 2 1/2 V. Power Tubes and one 280 or 282 Rectifier.

No. C1507..... **\$1.95**



Single Photophone Amplifier 2 Speaker

Built to exacting standards by RCA-Victor. Together they make a fine P.A. system for medium sized installation. SPECIAL PRICE ON COMPLETE OUTFIT. Amplifier, Speaker and Tubes. **\$21.50**



No. P15732—Single 250 Amplifier only **\$9.95**

No. Y19181—Speaker only **\$9.25**

No. P15733—Complete Kit matched tubes only **\$3.25**



R.C.A.-Victor Radio Speaker

Magnetic Speaker equipped with channel selection switch and volume control. Mounted in 2-toned walnut panel 13 1/2 x 11 1/2 x 1 1/4 ins. Ornamental grille. Natural reproduction with plenty of volume. No. W19170 **\$1.85**



Magnavox Speaker Specials

Quantity limited. Diameter 10c. Equipped with various transformers.

| Number | Field | Transformer |
|--------|----------|----------------|
| W19309 | 650 Ohms | Push-Pull 47's |

SPECIAL PRICE ON THE ABOVE **\$4.25**

W19312—With 9" cone, 2,500 ohmfield and P.P. 45 **\$3.75**



Tear out this advertisement, check the items you want and mail with your remittance. If you prefer, list your requirements in a letter by stock number and attach coupon below.

WHOLESALE RADIO SERVICE CO.
100 Sixth Avenue—Dept. C-123
New York, New York

Please send me your brand new catalog No. 55 just off the press!

Name

Address

City State

WHOLESALE RADIO SERVICE CO., INC.

100 SIXTH AVE. NEW YORK, N.Y.

SENSATIONAL- BIG BROADCAST Magazine Prices **SLASHED** Save 25% to 50%

RIGHT NOW is the time of the year when millions of subscriptions to favorite magazines expire. **RIGHT NOW** is the time to renew your subscription when prices, for a limited time only, have been sensationally reduced. Ordering at this time will mean a saving of several dollars for you. In assembling these many combination subscription offers we have made it possible that our readers obtain standard, popular magazines at the lowest prices obtainable. Only by special arrangement with a group of famous publishers has this great combination of magazines been made available at the unusually low cost. **NOW** you should order—at money-saving prices. It is most appropriate at this time of the year to send your friend his favorite magazine. Read over the various combination offers, and see how we bring you double values for only half the price. Then order your magazines today. Prices are going up—this is your protection for one year. **RIGHT NOW** sit down and send us the list. If books are to be sent to individual people, mention specifically the name of the magazine and to whom and where it should be sent. Don't miss this wonderful opportunity. All prices quoted are for subscriptions in U. S. A. only. Canadian and Foreign subscriptions require additional postage.

| OFFER NO. 1 | | |
|---------------|--------|---------------|
| Radio Craft | \$2.50 | OUR PRICE |
| Radio News | 2.50 | |
| Regular Price | \$5.00 | \$3.75 |

| OFFER NO. 2 | | |
|------------------|--------|---------------|
| Radio Craft | \$2.50 | OUR PRICE |
| Short Wave Craft | 2.50 | |
| Regular Price | \$5.00 | \$3.75 |

| OFFER NO. 3 | | |
|--------------------------------|--------|---------------|
| Radio Craft | \$2.50 | OUR PRICE |
| Everyday Science and Mechanics | 2.50 | |
| Regular Price | \$5.00 | \$3.75 |

| OFFER NO. 4 | | |
|-------------------|--------|---------------|
| Radio Craft | \$2.50 | OUR PRICE |
| Popular Mechanics | 2.50 | |
| Regular Price | \$5.00 | \$3.85 |

| OFFER NO. 5 | | |
|-----------------|--------|---------------|
| Radio Craft | \$2.50 | OUR PRICE |
| Popular Science | 1.50 | |
| Regular Price | \$4.00 | \$3.35 |

| OFFER NO. 6 | | |
|-----------------|--------|---------------|
| Radio Craft | \$2.50 | OUR PRICE |
| Modern Mechanix | 1.50 | |
| Regular Price | \$4.00 | \$3.35 |

| OFFER NO. 7 | | |
|------------------|--------|---------------|
| Radio Craft | \$2.50 | OUR PRICE |
| Christian Herald | 2.00 | |
| Regular Price | \$4.50 | \$3.50 |

| OFFER NO. 8 | | |
|---------------|--------|---------------|
| Radio Craft | \$2.50 | OUR PRICE |
| Photoplay | 2.50 | |
| Regular Price | \$5.00 | \$3.85 |

| OFFER NO. 9 | | |
|--------------------------|--------|---------------|
| Radio Craft | \$2.50 | OUR PRICE |
| Life or Judge (Only One) | 1.50 | |
| Regular Price | \$4.00 | \$3.25 |

| OFFER NO. 10 | | |
|---------------|--------|---------------|
| Radio Craft | \$2.50 | OUR PRICE |
| Delineator | 1.00 | |
| Regular Price | \$3.50 | \$3.00 |

| OFFER NO. 11 | | |
|---------------|--------|---------------|
| Radio Craft | \$2.50 | OUR PRICE |
| Pathfinder | 1.00 | |
| Regular Price | \$3.50 | \$3.00 |

| OFFER NO. 12 | | |
|---------------|--------|---------------|
| Radio Craft | \$2.50 | OUR PRICE |
| American Boy | 2.00 | |
| Regular Price | \$4.50 | \$3.50 |

| OFFER NO. 13 | | |
|----------------|--------|---------------|
| Radio Craft | \$2.50 | OUR PRICE |
| Motion Picture | 1.50 | |
| Regular Price | \$4.00 | \$3.25 |

| OFFER NO. 14 | | |
|---------------|--------|---------------|
| Radio Craft | \$2.50 | OUR PRICE |
| College Humor | 1.50 | |
| Regular Price | \$4.00 | \$3.25 |

| OFFER NO. 15 | | |
|---------------|--------|---------------|
| Radio Craft | \$2.50 | OUR PRICE |
| Screenland | 1.50 | |
| Regular Price | \$4.00 | \$3.25 |

| OFFER NO. 16 | | |
|---------------|--------|---------------|
| Radio Craft | \$2.50 | OUR PRICE |
| Silver Screen | 1.00 | |
| Regular Price | \$3.50 | \$3.00 |

| OFFER NO. 17 | | |
|---------------|--------|---------------|
| Radio Craft | \$2.50 | OUR PRICE |
| Golden Book | 3.00 | |
| Regular Price | \$5.50 | \$4.25 |

| OFFER NO. 18 | | |
|-------------------|--------|---------------|
| Radio Craft | \$2.50 | OUR PRICE |
| Review of Reviews | 3.00 | |
| Regular Price | \$5.50 | \$4.25 |

| OFFER NO. 19 | | |
|---------------|--------|---------------|
| Radio Craft | \$2.50 | OUR PRICE |
| Nature | 3.00 | |
| Regular Price | \$5.50 | \$4.25 |

| OFFER NO. 20 | | |
|---------------|--------|---------------|
| Radio Craft | \$2.50 | OUR PRICE |
| Scribner's | 4.00 | |
| Regular Price | \$6.50 | \$5.25 |

| OFFER NO. 21 | | |
|------------------|--------|---------------|
| Radio Craft | \$2.50 | OUR PRICE |
| Physical Culture | 2.50 | |
| Regular Price | \$5.00 | \$3.25 |

| OFFER NO. 22 | | |
|---------------|--------|---------------|
| Radio Craft | \$2.50 | OUR PRICE |
| Boys' Life | 1.00 | |
| Regular Price | \$3.50 | \$3.00 |

| OFFER NO. 23 | | |
|------------------|--------|---------------|
| Radio Craft | \$2.50 | OUR PRICE |
| Pictorial Review | 1.00 | |
| Regular Price | \$3.50 | \$3.00 |

| OFFER NO. 24 | | |
|----------------|--------|---------------|
| Radio Craft | \$2.50 | OUR PRICE |
| Wonder Stories | 2.50 | |
| Regular Price | \$5.00 | \$3.75 |

All Subscriptions Will Be Mailed to You Without Delay—Use the Coupon When Ordering



Makes an Ideal Gift for Anyone

Perhaps there is some friend out of town, or right near you, to whom you wish to carry your remembrance throughout the year. Then here is a good idea. Send him his favorite magazine, or one you know he will thoroughly enjoy. (You can even send a magazine subscription to your best lady friend.) A subscription to a magazine is always appreciated, and certainly brings remembrances. A courtesy card advising your friend of the kind donor will be sent to him or her bearing your name. Send one or more popular magazines to your friends or relatives.

over 50 GREAT COMBINATION SUBSCRIPTION OFFERS TO CHOOSE FROM on Your Favorite Magazines

The BIG "4" Offer

Grouped below are many of the outstanding magazines which can be taken in combination with RADIO CRAFT. The individual groups represent a substantial saving over the regular newsstand rate of all the books. ORDER TODAY.

| | | | |
|---|--|-----------------------------|------------------------|
| Radio Craft Modern Mechanix Wonder Stories Christian Herald | OFFER NO. 25 1 year } 1 year } 1 year } 1 year } | ALL FOUR ONLY \$6.00 | YOU SAVE \$2.50 |
| Radio Craft Popular Science Delineator Pathfinder | OFFER NO. 26 1 year } 1 year } 1 year } 1 year } | ALL FOUR ONLY \$4.50 | YOU SAVE \$1.50 |
| Radio Craft American Boy Motion Picture College Humor | OFFER NO. 27 1 year } 1 year } 1 year } 1 year } | ALL FOUR ONLY \$5.00 | YOU SAVE \$2.50 |
| Radio Craft Screenland Silver Screen Life or Judge (Only One) | OFFER NO. 28 1 year } 1 year } 1 year } 1 year } | ALL FOUR ONLY \$4.75 | YOU SAVE \$1.75 |
| Radio Craft Golden Book Review of Reviews Nature | OFFER NO. 29 1 year } 1 year } 1 year } 1 year } | ALL FOUR ONLY \$7.00 | YOU SAVE \$4.50 |
| Radio Craft Scribner's Nature Pathfinder | OFFER NO. 30 1 year } 1 year } 1 year } 1 year } | ALL FOUR ONLY \$6.50 | YOU SAVE \$4.00 |
| Radio Craft Physical Culture Life or Judge (Only One) Boys' Life | OFFER NO. 31 1 year } 1 year } 1 year } 1 year } | ALL FOUR ONLY \$5.00 | YOU SAVE \$1.50 |
| Radio Craft Modern Mechanix Pictorial Review Nature | OFFER NO. 32 1 year } 1 year } 1 year } 1 year } | ALL FOUR ONLY \$5.60 | YOU SAVE \$2.40 |



Your Choice of One or More of These Popular Magazines

- | | |
|--------------------------------|------------------------|
| Everyday Science and Mechanics | Boys' Life |
| Radio Craft | Woman's Home Companion |
| Short Wave Craft | American Boy |
| Wonder Stories | Golden Book |
| Popular Mechanics | Screenland |
| Radio News | Silver Screen |
| Popular Science | Photoplay |
| Modern Mechanix | Motion Picture |
| Christian Herald | Pathfinder |
| Life | College Humor |
| Judge | Pictorial Review |
| Delineator | McCall's |
| Review of Reviews | Physical Culture |
| Nature | Scribner's |

The BIG "Popular" Offer

RADIO CRAFT for One Year and your choice of a subscription to any two of the publications listed below, each for one year, at the special combination rate of **ALL 3 FOR \$4.15**

- | | | |
|--|--|--|
| Motion Picture College Humor Screenland Silver Screen | Physical Culture Boys' Life Pathfinder | McCall's Delineator Pictorial Review Woman's Home Companion |
|--|--|--|

Take Advantage of These Big Subscription Saving Offers—
ORDER TODAY!

RADIO CRAFT,
96-98 Park Place, New York, N. Y.

Gentlemen: Enclosed you will find my remittance of \$ _____ for which please send me Combination Offer No. _____, which consists of RADIO CRAFT and the following Magazines:

Name _____ Address _____
City _____ State _____
(For Canadian or Foreign Subscription rates on any combination offer, write for cost of additional postage.)

Fill out this section of the coupon if magazine is to be sent to a friend. DO NOT DETACH FROM OTHER HALF OF COUPON. If several magazines are to be mailed to friends, make duplicate coupons of this section only, one for each magazine to be sent. Write on plain white sheets.

Please send the _____ (Name of magazine) _____ to
Name _____
Address _____
City _____ State _____
Mention that it is sent by _____
(Print your name clearly)

The Radio-Craft Library Series covers accurately every branch of Radio—and thoroughly, too

Presented on this page are the new books of the RADIO-CRAFT LIBRARY—the most complete and authentic set of volumes treating individually, important divisions of radio. Each book has been designed to give radio men the opportunity to specialize in one or more of the popular branches of the industry. The material contained

in these books will increase your knowledge; you will find them a real help in your work and they will contribute to your money earning capacity. Read these books during your spare time at home. The authors of these books are well-known to everybody. Each one is an expert radio man; an authority on the subject—each is thoroughly

familiar with the field which he represents. This is perhaps the first real opportunity that you have ever had to build a radio library of books that are authentic, right-up-to-the-minute and written so that they are easily digested and clearly understood. Mail coupon below for your books.

TO THE RIGHT WILL BE FOUND A SHORT RESUME OF EACH BOOK

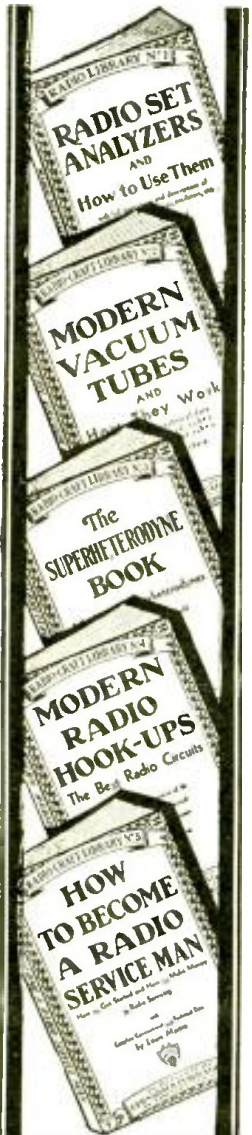

**Book No. 1
Radio Set Analyzers**

And How To Use Them
With Full Instructions and Descriptions of Set Analyzers, Tube Checkers, Oscillators, Etc.
By L. VAN DER MEL
This book explains thoroughly the operation of set analyzers, tube checkers, oscillators and other testing equipment. For every radio man this book is extremely helpful. It covers every phase of testing and gives you valuable short cuts; completely illustrated with photographs and diagrams to facilitate the use of modern testers. Recently reprinted.

**Book No. 2
Modern Vacuum Tubes**

And How They Work
With complete Technical Data on All Standard and Many Special Tubes
By ROBERT HERTZBERG
MODERN VACUUM TUBES describes the fundamental electron theory which is the basis of all vacuum tube operation, and goes progressively from the simplest two-element tubes right up to the latest pentodes and tlyratrons. It is written in clear, simple language and is devoid of the mathematics which is usually so confusing. Valuable reference charts and characteristic curves of standard and special tubes are to be found, also diagrams of sockets and pin connections.

**Book No. 3
The Superheterodyne Book**

All About Superheterodynes
How They Work, How to Build and How to Service Them
By CLYDE FITCH
There is no more fascinating a subject in the large array of radio circuits than the famous superheterodyne circuit. Whether you are a Service Man or experimenter, first-hand knowledge about the construction of superheterodyne receivers is very important. The book on Superheterodynes gives underlying principles of their construction, right from the very first set made.

**Book No. 4
Modern Radio Hook-Ups**

The Best Radio Circuits
A Complete Compendium of the Most Important Experimental and Custombuilt Receivers
By R. D. WASHBURNE
It is fascinating to the experimenter, or even to the up-to-date Service Man, to take a commercial set and to change it into one using a famous hookup that is not found in any manufactured set. Many excellent circuits have never been commercialized, but limited only to home set builders. Thousands of these popular circuits have been requested from time to time, and in this book we have included over 150 circuits, which include the famous Peridyme, Cash-Box A.C.-D.C. Set and others.

**Book No. 5
How to Become a Radio Service Man**

How to Get Started and How to Make Money in Radio Servicing
By LOUIS MARTIN
The ambition of many men in radio today is to become a first-grade Service Man. It is not as difficult as one might believe, but it cannot be done in a few short months. Following very carefully the advice of Mr. Martin, who has dealt with the problems of thousands of Service Men, this book deals very carefully with the essential stages in the preparation for qualifying as a Service Man.

**Book No. 6
Bringing Electric Sets Up to Date**

With Pentodes, Multi-Mus, Dynamic Speakers—Complete Information How to Modernize A.C., D.C. and Battery Operated Receivers
By CLIFFORD E. DENTON
In this country there are over ten million electrically operated receivers that could be modernized—by placing in them new type tubes, new speaker equipment and other modern improvements. This business of improving old sets can go to the experimenter and Service Men if they will quickly jump into action.

**Book No. 7
Radio Kinks and Wrinkles**

For Service Men and Experimenters
A Complete Compendium of the Latest Radio Short-Cuts and Money-Savers
By C. W. PALMER
It often becomes necessary for experimenters and Service Men to call upon their memory for some short cut or radio wrinkle that will solve a problem quickly. In business, "short cuts" mean time and money saved, and to the Service Man "time saved" means money earned.

**Book No. 8
Radio Questions and Answers**

A Selection of the Most Important of 5,000 Questions Submitted by Radio Men During the Course of One Year
By R. D. WASHBURNE
There have been collected a wide variety of questions which have come into our editorial files during the past two years, and only those whose answers would benefit the majority of men engaged in radio have been incorporated in this amazing question and answer book. A tremendously long list of topics is treated.

**Book No. 9
Automobile Radio and Servicing**

A Complete Treatise on the Subject Covering All Phases from Installing to Servicing and Maintenance
By LOUIS MARTIN
Automobile radios are up and coming, and someone has to service them properly. It therefore behooves you to read this immensely important new book on the art of Automobile Radio. The book is concise, and full of illustrations, photographs, diagrams and hookups.
A few of the really interesting chapters: Introduction; Automotive Radio Installations; Complete Descriptions of Commercial Automotive Receivers; Servicing Automotive Receivers; The Ignition System; General Service Consideration; Effects of Temperature on Power Supply; Conclusion.

**Book No. 10
Home Recording and All About It**

A Complete Treatise on Instantaneous Recordings, Microphones, Recorders, Amplifiers, Commercial Machines, Servicing, etc.
By GEORGE J. SALIBA
If there is one subject that is fascinating to every radio man, it is that of Home Recording. Of course, this volume is not all on "Home" recording, but the information contained therein is important to commercial radio men, studio operators, engineers and others interested in this phase of radio.
The art of recording and reproducing broadcast selections is becoming more important every day to radio men, experimenters and Service Men. Equipping dance halls, auditoriums, churches, restaurants and homes with public address systems and amplifiers brings many extra dollars and often an excellent income.

**Book No. 11
Point-to-Point Resistance Measurements**

The Modern Method of Servicing Radio Receivers
By CLIFFORD E. DENTON
Of the difficult problems which Service Men face today when repairing receivers, the greatest is that of replacing proper resistance values in sets. This task becomes even more difficult when the values of resistors are unknown, and manufacturers of many standard sets do not pass this information on to Service Men. In this new book radio men will find the information needed to quickly place a receiver in normal operating condition. This book cuts in half the time usually required to adjust the average set. Sufficient space has been devoted to the elementary problems and the theory of electricity as it is applied to resistance measurements, so that the Service Man will have a comprehensive idea as to how to overcome this problem.
Below you will find a partial list of the contents which will appear in this new book:
INTRODUCTION; Advantages of Resistance Measurement Method of Servicing for Radio Work; Basic Principles; Methods of Resistance Measurement; Resistors in Radio Receivers and Amplifiers; Point-to-Point Resistance Measurements in Typical Radio Set using Ohmmeter; Resistance Measurements using Modern Tester; Routine Testing where Circuit Diagram is Not Available; and where Resistances are Unknown; Relation of Voltage Tester Methods to Resistance Measurement; APPENDIX Resistance Charts, etc.

ALL BOOKS UNIFORM

The books in the new RADIO-CRAFT LIBRARY are all strictly up-to-date, and written by men who know their subjects. The volume, are all uniform size, 6x9 inches, and contain on an average of 50 to 120 illustrations. Each book is printed on fine book paper and no expense has been spared to make it an outstanding value, for its editorial contents as well as from the mechanical standpoint.

Clip Coupon and Mail Today!



GERNSBACK PUBLICATIONS, INC., 96-98 Park Place, New York, N. Y.

I have circled below the numbers of books in the RADIO-CRAFT LIBRARY, which you are to send me, and have deducted 20% for ordering five (5) books or more. I have included my remittance in full, at the price of 50c each, when less than five books are ordered.

The amount of my remittance is..... (Stamps, checks or money orders accepted.)
Circle number, wanted: 1 2 3 4 5 6 7 8 9 10 11

Name Address

City State RC-12-33

Big Discount to You

In order to make it possible for everyone to buy these books, the fifty (50) cent price has been made uniform for all volumes. You can buy these books separately, but you should take advantage of our special offer:

When Five (5) Books or More Are Ordered Deduct 20% from Your Remittance

Simply fill in the coupon at left, and mail it to us together with your remittance. Checks, stamps or money orders accepted.

\$50,000 SPEAKER CLEARANCE SALE!

SPECIAL - SALE - FEATURE

FARRAND INDUCTOR DYNAMIC



The Ideal Short Wave Receiver Speaker:
Eliminates Hum and Line Noise;
Draws Less Current;

Absolutely Genuine Farrand:
Compact in Size:
Brings in the Very Weak Short Wave Stations:

Do not confuse this model with the various similar types on the market, posing as Farrands. This is the true Farrand Inductor Dynamic. Its adaptation to Short Wave Radio Receivers has proven a popular step. The most inaudible stations are brought in with remarkable clearness without the customary noise and hum of regular dynamic speakers. Has two magnets parallel to each other with a bracket placed between them to facilitate mounting. Overall 9".

\$3.95

BOSCH SPEAKER CABINET



Will accommodate any magnetic or dynamic chassis up to 10" in diameter. A beautiful walnut cabinet artistically and expensively finished. It was built by one of the foremost manufacturers of cabinets. Grill contains a gold bronze cloth for contrasting color scheme.

Dimensions—12½" high, 12" wide, 10" deep.

Price **\$1.75**

JENSEN

Model D-7, A.C. DYNAMIC



Widely used as an additional speaker in many homes, as well as on public address systems. Will handle an enormous amount of volume without distorting or rattling. Equipped with a 280 rectifier tube. The speaker measures 12½" high, 11¾" wide, and 7 7/32" deep. Baffle opening required, 10". Supplied complete with tube. **\$8.95** D.C. Model **\$6.95**

PEERLESS

A.C. and D.C. DYNAMIC SPEAKER CHASSIS



Adaptable for the most powerful amplifier. Equally suited for use with any receiver employing the average type of audio amplification system.

Operating as low as 90 volts "B" current. D.C. model has a 1,000 ohm field and a pushpull output transformer; A.C. model used a dry rectifier system with a hum condenser for minimum A.C. hum.

Dimensions—12" high, 8" deep.

A.C. Model. Price. **\$8.95** D.C. Model. Price. **\$6.95**
6 Volt. Price..... **\$7.95**

Limited Quantity!

GENUINE R. C. A. MAGNETIC CHASSIS

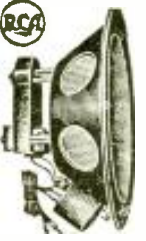

This chassis is the identical one used in the R.C.A. 100A-100B and 103 Speakers which list for as high as \$35.00. Note built-in output transformer which permits use of 450 volts without distortion, rattling or blasting. Generous oversized magnet. The thick armature is accurately centered, the sturdy metal frame is lined with a special self-balling fabric, greatly improving acoustic properties of this sensational speaker. Note the corrugated surface of the cone, an exclusive feature—enhances perfectional reproduction qualities considerably; most compactly made; 9" outside diameter, 4½" deep overall.

Price **\$2.75**

Price Going Up. Buy Now!

Stromberg-Carlson

MAGNETIC PICKUP



The season for public address amplification is here. For perfect tonal quality and service insist on a genuine STROMBERG-CARLSON PICKUP. Little has to be said about it—Stromberg-Carlson quality is known the world over. Price includes a Stromberg-Carlson Head, Arm, Matching Transformer, Pickup Plug and 20-Foot Insulated Extension Cord.

BUY NOW! This Low Price For a Short Time Only!

Price Complete **\$5.50**

FARRAND 12" MODEL INDUCTOR DYNAMIC



The 12" models have two magnets standing upright, with a bracket on the bottom to ease mounting. Dimensions of the 12" model: 12" high and 6½" deep. (12" Model)

Our Price **\$5.95**

OXFORD A.C. and D.C. CONCERT



11½" concert model. Three point suspension balanced cone types. A.C. uses 280 rectifier. D.C. models have a field resistance of 2,500 ohms. Output transformer may be had for single or push pull output tubes.

A.C. with Tube..... **\$5.75**
D.C. Model **\$4.50**

OXFORD A.C. or D.C. Auditorium DYNAMIC



14" auditorium model. Takes a haffle with a 1½" opening. Oversize frames with extra gauge wire in the field coil, which gives the speaker higher field strength and permits greater energization. D.C. model has a 4,000 ohm field which can be energized from the power packs of amplifiers or from 110 volt D.C. line.

A.C. with 280 Tube..... **\$9.95**
D.C. Model **\$7.95**

All orders are F. O. B. New York, and subject to prior sale. Terms: A deposit of 20% is required with every order. Balance may be paid on delivery. Deduct 2% if full amount is sent with order.

DO NOT SEND FOR CATALOG

GREN PARK COMPANY

245 Greenwich St. Dept. RC New York, N. Y.

RTC's Big December SPECIALS

Every month we list on this page a few STAR★ items which are not listed in our catalog. These are all specials on which the quantities on hand are not sufficient to catalog them. *Once sold out, no more can be had.* ORDER NOW—TODAY.



No One in Radio Undersells Us!

STOP SHOPPING—the lowest prices are right on this page. *No one undersells us.* We meet any price on any new merchandise. Order direct from this page and save money. 100% satisfaction on every transaction. Take advantage today of these special offers.

★ "FARADAY" 7 TUBE SCREEN-GRID RADIO RECEIVER

Complete with Full Dynamic Speaker
ONLY 65—NO MORE WHEN GONE

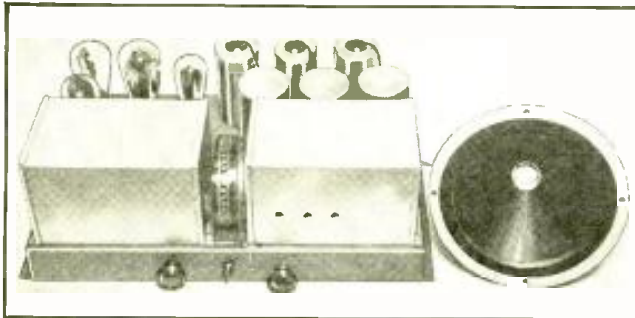

If ever there was a greater value than this before, we have yet to see it. The selectivity and sensitivity of this 7 tube receiver, due to its 3 tuned stages are just as sharp as those of a super-heterodyne receiver. The construction of this set is best described as "Standard." Its circuit is none other than the "good-old-standby" T. R. F. type which is the most fool-proof ever designed. It incorporates two stages of tuned R. F. amplification using type 24 screen-grid tubes; a type 24 power detector; a single stage of type 27 A. F. voltage amplification and finally a push-pull stage using 2-45 tubes. The set is sold complete with a matched, full dynamic speaker.

Tuning is extremely simple. The knob on the left is a combination volume control and power switch. The knob on the right is the station selector. The toggle switch in the center enables you to control the tone from high treble to deep bass. Coils, tuning-condenser, slug, filter bank, filter choke, bypass condensers, etc., are all thoroughly shielded. The chassis itself is made of heavy gauge metal.

This receiver is not the midjet type. It is a full-sized chassis having qualities which are found in the miniature sets. The use of three tuned circuits employing screen grid and high gain R. F. transformers together with careful wiring and bypassing, results in high sensitivity. Despite the mass of new tubes recently thrown on the market, it is generally conceded that for average home use the type 45 tubes in push pull arrangement supplies adequate power with the least distortion.

Here is an excellent opportunity for you to see men to "clean-up." There are little more than 100 of these receivers left and at this low price are bound to give out in very short order. *Have "best customer first served."* The moral is "do not delay—order today." Measures 19 1/2" wide by 7 1/2" high by 12 1/2" deep overall. Employs the following tubes: 3-24, 1-27, 2-45 and 1-80. All high grade parts such as Aerovox condensers (largest volume control, etc., are used).

No. SP-2001 "Faraday" 7 Tube Screen Grid T. R. F. Receiver including dynamic speaker but less tubes
YOUR PRICE \$11.96

BUILD "NEW DEPENDABLE" TUBE TESTER

Sold Either Wired or in Kit Form

Here indeed is your opportunity to build one of the finest tube checkers ever designed—an instrument which is MODERN in every sense of the word. Will test all the latest type tubes, including those with ANI & PRONGS—DIRECTLY—without the use of a "slugg adapter"

The "NEW DEPENDABLE," despite its high degree of accuracy, is extremely simple to operate. Both plates of the 80—82 83 and other rectifier tubes are readily tested without the use of a "second plate" button.

The instrument employs a high-grade, D'ARSONVAL TYPE MOVING-COIL METER, insuring thereby extreme accuracy. This instrument will check more than 120 different tubes and even those which have not as yet been placed on the market. The tube tester is amply guarded against tube "shorts," which condition is indicated by the flashing of a small pilot light. All component parts are mounted on a beautifully etched panel and the entire constructed, leatherette-covered, carrying case. For operation on 105-125 volts, 50-60 cycles, A.C. This instrument is available either in kit form or completely wired and tested, ready to use. Shipping weight 9 lbs.

No. 303 "New Dependable" Tube Tester, completely wired and tested.
YOUR PRICE \$18.74

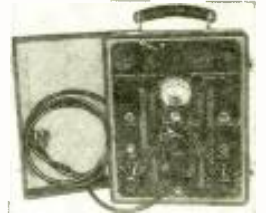

No. 303 A "New Dependable" Tube Tester in kit form.
YOUR PRICE \$14.74

NEW NEW NEW Service Men's Wire Wound Fixed Resistor Kit

Only 100 Kits Left

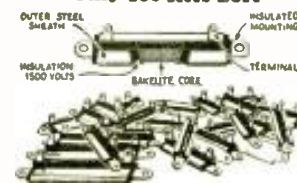

You have probably never seen a resistor of this type before. It is new, it is radically different from other resistors, both in construction, accuracy and maintenance of calibration. These resistors are around the fine wire resistors, elements, protectors it insulates and maintains of calibration. These resistors are produced at a rate. A resistor of this type may be used over and over again from set to set without losing its calibration or wearing out.

The kit consists of 24 resistors, only four of which are duplicated. In other words there are more than 20 different values. If these units were bought individually, they would cost more than \$6.50. **CONTENTS:** The kit contains one each of the following values: 20 ohms C.T., 40 C.T., 60 C.T.; 50 ohms, 100, 150, 250, 300, 400, 600, 1250, 1500, 2000, 2500 and 3000, and two each of the following: 200 ohms, 500, 750 and 1000.
No. "Mu-Kit" Service Men's Wire Wound Fixed Resistor. **YOUR PRICE \$2.75**

A Real Microphone at the Price of a Toy

Here is the largest value ever offered in a commercial type microphone! An unusually large two-button microphone, ruggedly constructed and designed especially for broadcast purposes. Frequency range 80 to over 5,000 cycles—adequate for all speech and music reproduction. **EXCELLENT FOR PUBLIC ADDRESS WORK.** Stretched cushioned diaphragm of duralium with pure gold center contacts on buttons and diaphragm. Standard 200 ohms per button. Finished in beautiful polished chrome. Net weight 1 1/2 lbs. Ship weight 2 3/4 lbs.
No. "F" 2 Button Mike **\$4.95**
YOUR PRICE



FREE RADIO AND SHORT WAVE TREATISE

Avail yourself now of the opportunity to receive the FREE 1933 Edition of our Radio and Short Wave Treatise—116 solid pages of useful information, radio news, diagrams and illustrations. Possibly the greatest value in radio—NOT JUST ANOTHER CATALOG. Contains a large editorial section with valuable information not found anywhere else. Special consideration has been given to the radio beginner in this issue. Among the new technical information listed are the following:

HERE IS A PARTIAL LIST CONTENTS

Fundamental Principles of Radio—Ohm's Law—Discussion of New Tubes—Constructing a "Triple-Twin" Amplifier—All about Superheterodynes—Eliminating Man-Made Static—Constructing a Two-Tube Short-Wave "Globe-Trotter" Receiver—\$3.00 Prize Suggestions—Radio Kinks, etc., etc.

WRITE TODAY. Enclose 4 cents for postage. Treatise sent by return mail.

Over 100 New Hook-Ups, Etc. 1000 Illustrations.

RADIO TRADING Co.
Main Place New York City

NEW READRITE MODEL 710 ANALYZER TESTS LATEST TYPE 6 AND 7 PRONG TUBES

NINE METER SCALES AVAILABLE

This new Readrite precision instrument embodies features which have always been desired in any instrument built for service work: (1) low cost; (2) simplicity of design; (3) accuracy of measurements; (4) ruggedness of the complete unit. It is needless to add that the kit is capable of testing anything from old battery models to the latest screen-grid, Pentode, and multi-tube receivers.

The Model 710 is an extremely compact device. The outside dimensions of the carrying case are only 10 3/4 by 7 1/4 by 3 1/4 inches. The analyzer contains a D.C. voltmeter, an A.C. voltmeter and a milliammeter. The D.C. voltmeter has four ranges: 0 to 10, 0 to 50, 0 to 500 and 0 to 500 volts. The A.C. voltmeter has three ranges: 0 to 10, 0 to 140, and 0 to 700 volts. The milliammeter has two ranges, one for 15 mill. reading and the other for 150 mill. This variety of ranges makes it possible to test every conceivable radio circuit; high voltage secondary of power transformers, current drain of all radio tubes, including the high power 250 and 210 tubes, etc.

CONVENIENT SELECTOR SWITCH—The instrument is equipped with a ten position bipolar selector switch, by means of which readings may be obtained of "C" volts, "C" volts reversed, "K" volts, "K" volts reversed, plate voltage, screen-grid voltage, etc. A 4 1/2-volt battery is supplied with the analyzer, to provide "hot" bias for grid tests, continuity tests, etc.

TEST PENTODES—"MULTI-MU" 57's and 58's—80 RECTIFIERS, Etc.—There are four sockets on the panel of the analyzer to take care of the four, five, six and seven prong tubes. There is a "grid-test" push-button. Pin jacks are available for the individual use of all meters, externally, in every range. There is a screen-grid pin jack and there are two pin jacks for connecting the external battery. Both plates of the 80-type rectifier may be tested by use of a special adapter furnished. Charts are provided for measuring resistances and capacities. The Analyzer is furnished complete with test leads, connecting cables, Burgess 4 1/2-volt battery, several battery leads, U. S. adapter, 80 rectifier adapter and resistance and capacity charts. Shipping weight 8 lbs.
Model 710 Analyzer. List Price, \$27.50.
YOUR PRICE \$16.18



WE ARE A WHOLESALE HOUSE AND CAN NOT ACCEPT ORDERS FOR LESS THAN \$3.00. If C.O.D. shipment is desired, please remit 20% remittance, which must accompany all orders. If full cash accompanies order, deduct 2% discount (except on Readrite 710 Analyzer). Send money order—certified check—U. S. Stamps.

ORDER FROM THIS PAGE You will find special prices from time to time, in this magazine. Get our big FREE catalog for the greatest Radio Bargains. Should you wish goods shipped by parcel post, be sure to include sufficient extra remittance for same. Any excess will be refunded.

Radio Trading Company 102 Park Place New York, N. Y.

Supreme gives you today what others will offer tomorrow



MASTER
DIAGNOMETER



Supreme engineered all equipment into one complete instrument—the DIAGNOMETER. Competition followed with combinations of various types.

Supreme invented the snap catch analyzer plug—Competition had to follow suit.

Supreme pioneered the A.C.-D.C. single meter analyzer. Competition followed the leader.

And Now—Supreme's exclusive "FREE REFERENCE POINT SYSTEM OF ANALYSIS." Imitators are bound to again follow Supreme leadership.



MODEL 91
SUPREME ANALYZER

Radiomen who set the pace in modern radio technique look to the line of instruments which have demonstrated their ability time and again to set the pace in modern scientific development. And now Supreme offers an improved method of complete analysis through an analyzing cable and patented adapter—locking plug, greater speed, flexibility, efficiency, and complete banishment of obsolescence are now made possible by Supreme's new "FREE REFERENCE POINT SYSTEM OF ANALYSIS."

This new system, owing to its extreme flexibility, is unaffected by even a complete re-arrangement of the connections of tube elements to the tube terminals and so simple that any radioman can instantly apply it to his testing procedure and new developments as they occur. Referring to the accompanying drawing it will be seen that the numbers around the controls conform to the R.M.A. System for identifying the terminals of tubes; two spare (abbreviated "SPR"), settings are provided for possible 8 or 9 terminal tubes.

The controls as shown in the drawing are set for measurements between the terminals numbered 1 and 2 of the new KR-1 automotive radio rectifier tube. By the new RMA system for designating tube terminals, the number 1 terminal of this tube is connected to the cathode element, while the number 2 terminal is connected to the plate. These controls are, therefore, correctly set for measuring the AC plate potential of this tube when the "VOLTS" button is depressed, or the resistance between these terminals when the "OHMS" button is depressed. A separate control, not shown in the accompanying drawing, is used for selecting the various meter ranges. Since the "SELECTOR 1" is used also for current measurements, the "MILS." button may be depressed for reading the cathode current, which in this tube is the same as the plate current, but the plate current can be measured by rotating "SELECTOR 1" to position "2" and depressing the "MILS." button.

The controlling grid of a type 24 tube is connected to the "top cap"



terminal of the tube; the connections to the "top cap" circuits are abbreviated "T. C." on the accompanying drawings. The screen grid corresponds to the No. 1 terminal, the plate to the No. 2, the heater to No. 3 and No. 4, and the cathode to No. 5. All potential measurements should be made with reference to the cathode of No. 5 terminal, so that one of the controls should be set at No. 5 while the other control is rotated to the "T. C." position for the control grid potential measurement, to the No. 2 position for the plate potential measurement, etc. In this type, the tube test is accomplished by setting the "SELECTOR 1" control at the No. 2 position and the "SELECTOR 2" control at the "T. C." position, and depressing the "MILS." button for the first reading, followed by the "TUBE TEST" button for the second reading, after which both buttons are released.

The two plates of the conventional types, 80, 82 and 83 rectifier tubes are connected to the No. 1 and No. 2 terminals, and the applied potentials are measured with respect to the filament which is connected to the No. 3 and No. 4 terminals. One of the controls should be set at the No. 3 or No. 4 position, and the other at the No. 1 position for one plate potential measurement and at the No. 2 position for the other plate potential measurement. To measure the AC potential between the two plates, one of the controls should be set at No. 1 position and the other at the No. 2 position. For each potential measurement, the "VOLTS" button should be depressed, as the meter is not applied to any circuit until a button is depressed, thereby providing positive protection to the meter.

These few examples will suggest to the professional radioman the innumerable measurements which are possible by this simple arrangement which constitutes the SUPREME FREE REFERENCE POINT SYSTEM OF ANALYSIS.

Eventually, you pay for Supreme standards, Supreme engineering foresight, Supreme quality construction, Supreme skill and speed—why not enjoy its economy in the beginning—NOW!

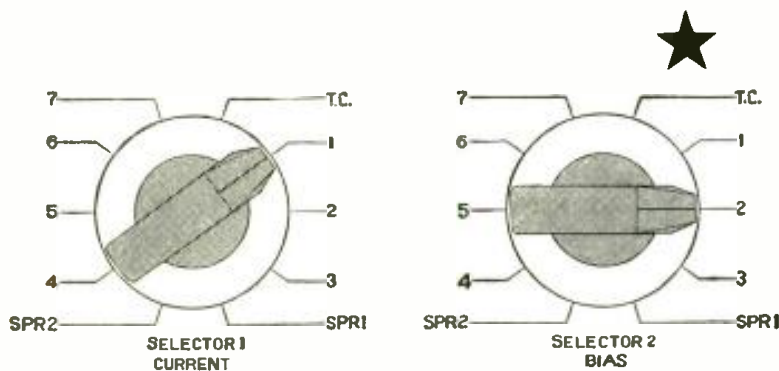

THIS COUPON WILL BRING YOU
THE NEW 1934 SUPREME CATALOG

SUPREME INSTRUMENTS CORP.
475 Supreme Bldg., Greenwood, Miss.

Gentlemen:
Please send me, without obligation, absolutely free,
your new 1934 Catalog.

Name _____
Address _____
City _____ State _____
Jobber Preference _____

Ask your Jobber for a demonstration. Meanwhile, inform yourself of the most up-to-date development in the science of radio testing equipment by sending for the 1934 Supreme Catalog—Free. See Coupon.



I saved 1/2 by buying direct from the Midwest Laboratories

Yes, and it gives you WORLD-WIDE Reception!

Amazing New SUPER Deluxe

16-TUBE ALL-WAVE Radio

9 TO 2,000 METERS



New FREE CATALOG WRITE TODAY!

30 DAYS FREE TRIAL

THOUSANDS of satisfied customers have saved from 1/3 to 1/2 on their radios by buying direct from Midwest Laboratories. You, too, can make a positive saving of 30% to 50% by buying this 16-tube DeLuxe ALL-WAVE radio... finest development of Midwest's 14 years experience as leading radio manufacturer... at the sensationally low direct-from-laboratory price of only \$49.50. You'll be amazed and delighted at its super performance! It brings in broadcasts from stations 10,000 miles and more away. Gives complete wave length coverage of 9 to 2,000 meters (33 megacycles to 150 KC). Send for the big FREE catalog today! This bigger, better, more powerful, clearer-toned, superselective radio has FIVE distinct wave bands: ultra short, short, medium, broadcast and long...putting whole world of radio at your finger tips. Now listen in on all U. S. programs...Canadian, police, amateur, commercial, airplane and ship broadcasts...

and world's finest stations as: DFA, Nauen, Germany—REN, Moscow, Russia—EAQ, Madrid, Spain—12RO, Rome, Italy—VK2ME, Sydney, Australia. Never before so much radio for so little money. Don't buy any radio until you learn about this greatest of radio values. Send today for money-saving facts!

40 NEW 1934 FEATURES

Try this Midwest radio...in your own home...for thirty days before you decide. See for yourself the 40 new 1934 features that insure amazing performance. For example—

Automatic SELECT-O-BAND (exclusive with Midwest), simplifies short wave tuning, instantly pointing out wave length of the station.

Other features include: Amplified Automatic Volume Control, 16 New Type Tubes, Balanced Unit Superheterodyne Circuit, Velvety Action Tuning, Super Power Class "A" Amplifier, 29 Tuned Circuits, New Duplex-Diode-High Mu Pentode Tubes, No-Image Heterodynes, Full Rubber Floated Chassis, Variable Tone Blender, Centralized Tuning, 7 KC Selectivity, New Thermionic Rectifier, Totally Scientifically Shielded (coils and switch catacombed), etc. These and many additional features are usually found only in sets selling from \$100 to \$150.

WONDERFUL FOREIGN RECEPTION

 NEWBERRY, S. C. — My Midwest 16 is the finest radio I ever heard. I have tuned in "everything" in United States, Canada and Mexico. Have picked up stations in South America, England, France, Spain, Germany, Italy. Also airplane and ship transmitters, police stations, and numerous "ham" phone and code transmitters.
 WILBUR LONG, JR.,
 746 Pope St.

TERMS AS LOW AS \$5.00 DOWN

DEAL DIRECT WITH LABORATORIES

Increasing costs are sure to result in higher radio prices soon. Buy before the big advance...NOW, while you can take advantage of Midwest's amazingly low prices. No middlemen's profits to pay! You save from 30% to 50% when you buy direct from Midwest Laboratories...you get 30 days FREE trial—as little as \$5.00 down puts a Midwest radio in your home. Satisfaction guaranteed or your money back! FREE catalog shows sensational radio values. Write TODAY!

SAVE UP TO 50%

WORLD'S GREATEST RADIO VALUE

\$49.50

with New **Deluxe Auditorium Type SPEAKER**

BIG FREE CATALOG

The 24-page catalog shown above pictures the performance curves of this super radio. It illustrates a complete line of beautiful, artistic, de luxe consoles... in the new modernistic designs... priced to save you 30% to 50%. You can order your Midwest radio by mail with as much certainty of satisfaction as if you were to select it personally at our great radio laboratories. Write for your FREE catalog NOW!



RUSH THIS COUPON FOR AMAZING 30-DAY FREE TRIAL OFFER AND NEW 1934 CATALOG

MIDWEST RADIO CORP.,
 Dept. 350
 Cincinnati, Ohio.

Without obligation on my part send me your new FREE 1934 catalog, and complete details of your liberal 30-day FREE trial offer. This is NOT an order.

AGENTS! Make Easy Extra Money
 Check Here for Details

Name.....
 Address.....
 City..... State.....

MIDWEST RADIO CORP.

DEPT. 350 — CINCINNATI, OHIO, U. S. A.

Established 1920 Cable Address: Mfira. o. ABC 5th Edition